

## DU55C

GPO Display [InteracTables](#) series offers multi-touch functionality with a wide variety of housing options. All InteracTable models feature capacitive touch, commercial-grade LCD panels and options for embedded PC and custom logos/colors.



**DU55C-PD (Pedestal)**

Pedestal InteracTables are perfect for housing devices such as desktop PCs within the cabinetry below the display. This makes for an attractive, self-contained touch table where cabling, computing and other components are both obscured from view and locked away to prevent access.

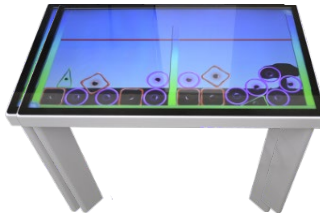

**DU55C-LB (Lobby)**

Standing 21" in height, the Lobby table design provides ideal touch access for users seated on couches or waiting-room tables. The lower height and traditional four-leg design of this InteracTable gives it a "coffee table" feel- the ideal addition to any lobby or entranceway.



**DU55C-FT (Flow-Thru)**

The Flo-Thru table design offers striking housing along with a hidden access panel for running cabling and hiding small form-factor PCs or other devices.



**DU55C-TR (Table-Ready display)**

The Table-Ready display is ideal for integration with existing table housing or cutouts. While GPO Display offers a wide range of turnkey tables, the Table-Ready display can be placed in much larger conference tables, wooden tables, and more.



**DU55C-SP (Staple)**

The Staple design combines the unique, eye-catching elements of the "Flo-Thru" with spacious cabinetry for PCs and other devices. These can be easily accessed by a door that opens to the bottom/interior of the table housing.



**DU55C-AD (Auto-Adjustable)**

*10-90 degrees*

Adjustable InteracTables allow users to angle the touch screen in increments of thirty degrees. This allows for "drafting table" applications as well as flat table surfaces with the same InteracTable.

- ✓ **P-CAP 10pt touch**
- ✓ **Water-resistant surface**
- ✓ **Housing can be modified upon request for variable height, screen angle, color**
- ✓ **Built-in Speaker (10W x 2)**
- ✓ **Optional Touchtech Lima software for swiping of content to extended desktop/video wall**
- ✓ **Optional PC**

\* GPO Display may change specifications and designs without notice.

## DU55C

Model	DU55C-PD	DU55C-LB	DU55C-FT	DU55C-TR	DU55C-SP	DU55C-AD
Design Type	Pedestal	Lobby	Flo-Thru	Table-Ready	Staple	Auto-Adjustable

### Panel Attributes

Screen Size (Diag.)	55"
Panel Technology	Commercial-grade S-PVA / Direct-LED
Resolution	1920 x 1080
Pixel Pitch (mm)	0.630 (H) x 0.630(W)
Surface Treatment	Hard coating (3H), Haze 44%
Brightness (Typ.)	500nit
Contrast Ratio (Typ.)	4,000:1
Displayable Colors	8bit(D), 16.7 Million colors
Viewing Angle	178° (min) / 178° (min)
Response Time (Typ. GtG)	8ms
Aspect Ratio	16:9

### Dimensions, Power & Other

Dimension (W x H x D)	See mechanical drawings
Electrical Ratings	AC 100 - 240V (50/60Hz)
Power Consumption (Typ.)	160W / 1.9A
Standby Power Consumption	>0.5W
Internal Speaker	10W x 2
Operating Temperature	32°F - 122°F
Operating Humidity Range	20~90% , non-condensing
Industrial Reliability	50,000+Hours
Warranty	One Year (parts & labor)

### Connectivity

HDMI (for internal PC Input)	1
VGA (for user PC input)	1
IR Sensor	1
Power LED	1
Power switch	1
External USB port	2
External AC inlet	1
External LAN port	1

### Touch Specification

Technology	Projected Capacitive Touch
Resolution	15360 x 8640
Touch Accuracy	Within 2mm
Response Time	15-30ms
Interface	USB 2.0, HID-Compliant, Plug & Play
Simultaneous Touch Points	10 pt
Supported OS	Windows / Android / MAC / Linux
Min. Touch Object Size	9mm
Detection Method	Finger

\* GPO Display may change specifications and designs without notice.

# Optional Features

## 4K Mini PC (IMM700)

This small form factor PC is the perfect complement to a wide range of GPO Display products. From InteracTables to 4k monitors, the [IMM700](#)'s powerful graphics card and support of Ultra HD content allows users to get the most of their displays. Dual HDMI outputs allow for high-res extended desktops and “pick ‘n flick” swiping of content using [Touchtech Lima](#) software- the ideal complement to an InteracTable/Video Wall setup.

### PC Specification

Operating System	Windows 10
CPU	Intel Broadwell Core™ i5-5250U 2.7Ghz
GPU	Intel® HD Graphics 6000
RAM	DDR3L 8GB
ROM	128G SSD (Can be extended to 512GB, please contact our customer service for specific requirements about the ROM)
Wi-Fi Connectivity	802.11 B/G/N 300M WIFI
Ethernet	WLAN Card/LAN Card 1000M
Bluetooth	3.0
Video Supported	3GP, AVI, H.264, MP4
Audio Supported	AAC, ACC, MP3, OGG, WAV
Office Format	Excel, PPT, Word
E-book Format	PDF, TXT
HDMI Port	Dual Standard HDMI Male 1.4b (support up to 3840 x 2160)
Other Interfaces	SD Card Slot: Yes USB Host: Yes 1 x USB 3.0+1 x USB2.0 Micro HDMI slot: Yes RJ45 connector: Yes DC Jack: Yes 3.5mm Headphone Jack: Yes Burglar-proof Padlock: Yes
Power	100-240V 12V 2A
Power Consumption	15W
Others	Skype: Supported; YouTube: Supported; Speaker: Supported MIC: Supported
Dimension	230 x 180 x 45 (mm)
Dimension (Packed)	315 x 260 x 80 (mm)



Product specification and design are subject to change without notice.

Copyright 2017, GPO Display. All rights reserved. This document may not be copied in any form without written permission from GPO Display Rev. 020117-R01

# Pedestal Design

Mechanical Drawing



DU55C-PD

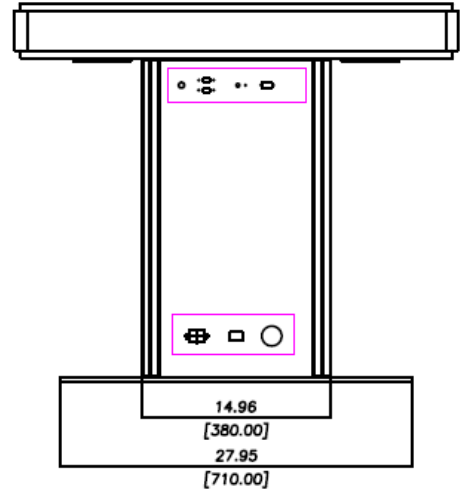
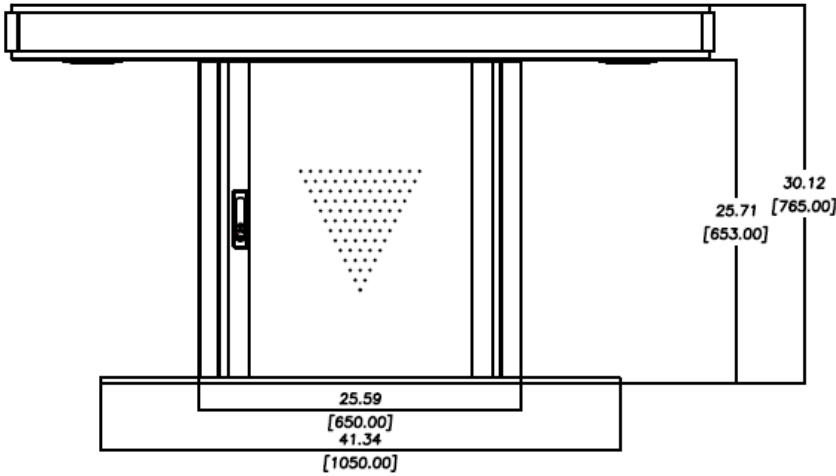
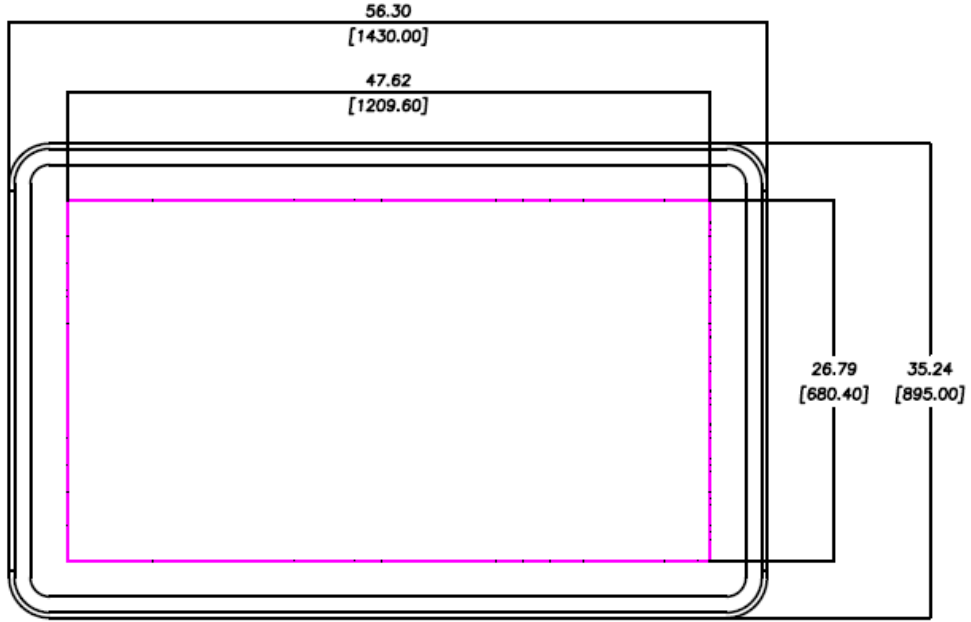

Product specification and design are subject to change without notice.

Copyright 2017, GPO Display. All rights reserved. This document may not be copied in any form without written permission from GPO Display Rev. 020117-R01

# Flo-Thru Design

Mechanical Drawing



DU55C-FT

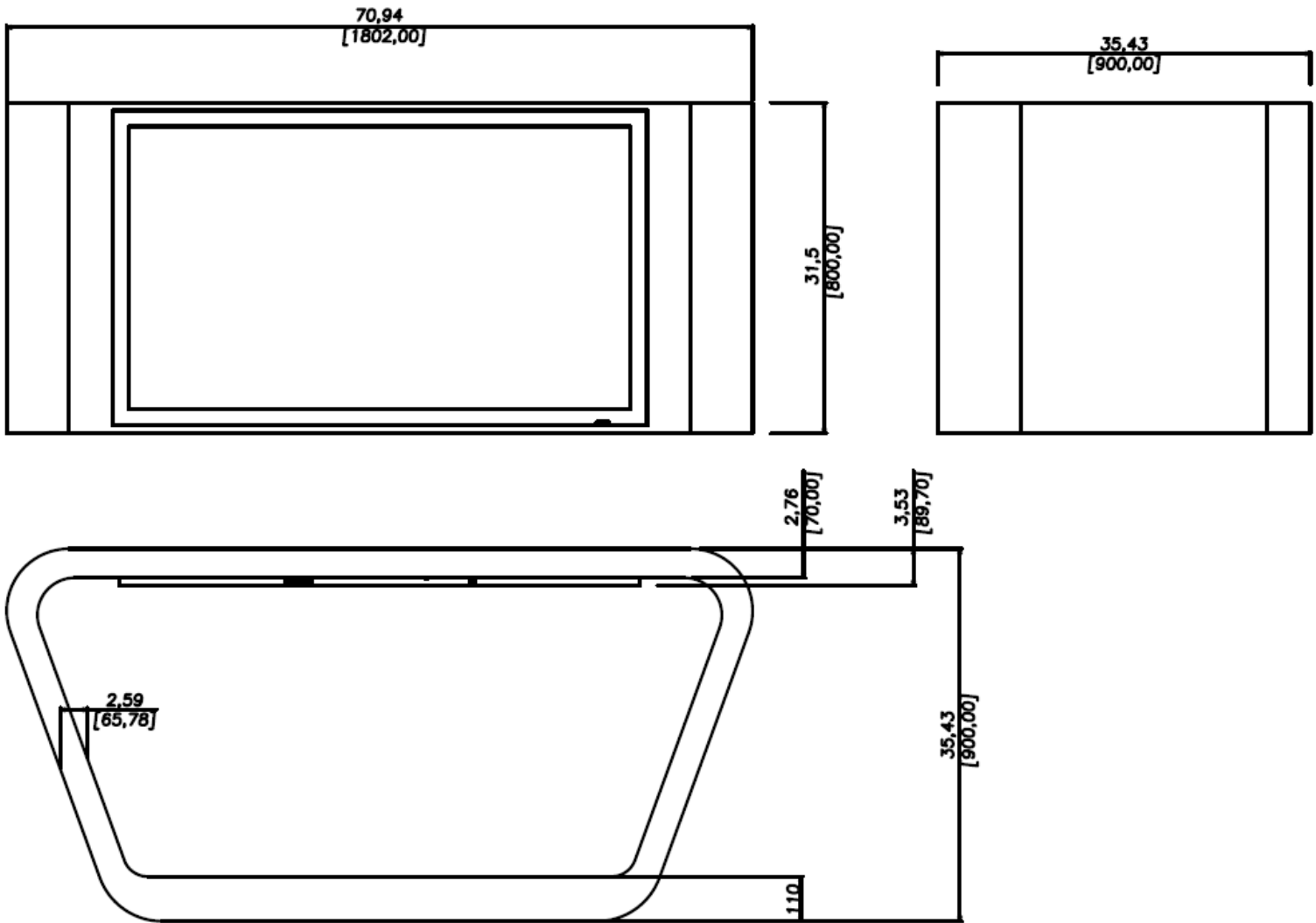

Product specification and design are subject to change without notice.

Copyright 2017, GPO Display. All rights reserved. This document may not be copied in any form without written permission from GPO Display Rev. 020117-R01

# Lobby Design

## Mechanical Drawing



DU55C-LB

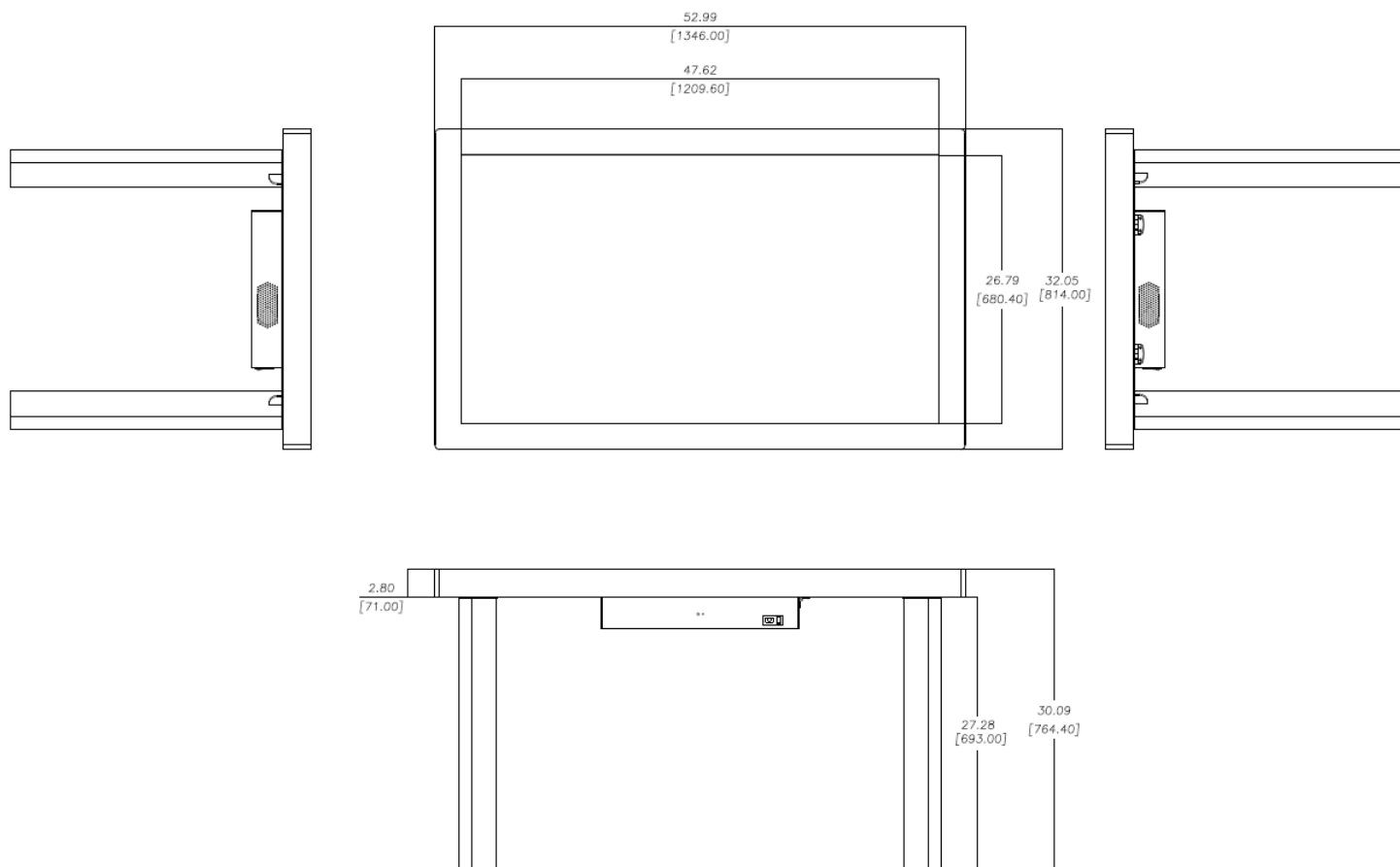

Product specification and design are subject to change without notice.

Copyright 2017, GPO Display. All rights reserved. This document may not be copied in any form without written permission from GPO Display Rev. 020117-R01

# Lobby Design

## Mechanical Drawing



DU55C-AD

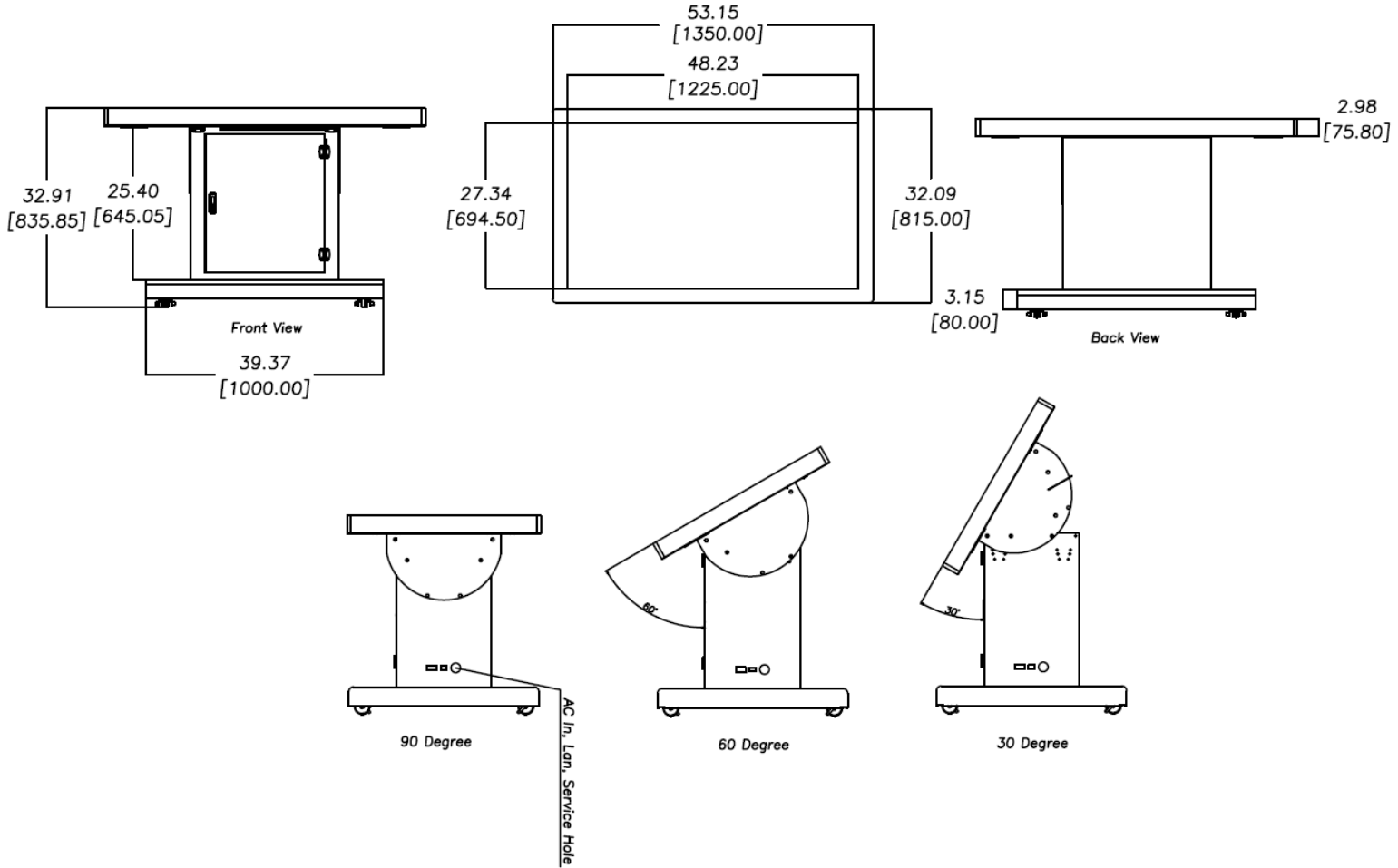

Product specification and design are subject to change without notice.

Copyright 2017, GPO Display. All rights reserved. This document may not be copied in any form without written permission from GPO Display Rev. 020117-R01