



DN46HE



User Manual

Virtual Skylight Display DN46HE

Important Safety Instructions

1.  To reduce the risk of fire or electric shock, do not expose this appliance to rain or other forms of moisture.
2.  Indoor Use Only
3. Display must not be exposed to liquids via dripping or splashing. Please do not place liquid –filled items such as vases near the display.
4. Use only a properly grounded plug and receptacle.
5. CAUTION – These instructions are for use by qualified service personnel only. To reduce the risk of electric shock, do not perform any service other than that contained in the operating instructions unless you are qualified to do so.
6. Do not use a damaged or loose plug.
7. This may cause electrical shock or fire.
8. Operate the display only from a power source (i.e. voltage) indicated in the product specification.
9. Otherwise the product can be damaged, fire can occur or you may be electrocuted. If you are not sure what type of power supply you have, consult a certified electrician.
10. In the presence of thunder and lightning, never touch the power cord and signal cable because it can be very dangerous.
 - ▶ This can cause electric shock.
11. Do not connect several extension cords, electrical appliances or electrical heaters to a single outlet. Use a power strip with a grounding terminal designed for exclusive use with the computer.
 - ▶ A fire can break out due to overheating.
12. Do not touch the power plug with wet hands. Additionally, if the cord pin is wet or covered with dust, dry the power plug completely or wipe dust off before plugging in the cord.
 - ▶ You may be electrocuted due to excess moisture.
13. Insert the power plug firmly so it cannot come loose.
 - ▶ A loose connection can cause fire.
14. When disconnecting the display from an electrical outlet, the plug must be pulled out from the socket. Do not remove power cord from outlet by pulling from the cord. Pull from the plug head.
15. Hold the plug when pulling out the power cable. Do not pull the plug out by the wire. Do not bend the power cord with excessive force or put heavy objects on the power cord.
 - ▶ The power line can be damaged, which may cause electric shock or fire.
16. Do not insert metal or other conductive materials into the product openings. Additionally, do not touch the power cable right after plugging into the wall input terminal.
 - ▶ You may be electrocuted.
17. The appliance coupler is used as the disconnect device.
18. Please make sure the device is installed near the wall outlet to which it is connected and that the outlet is easily accessible.
19. Do not unplug the power cord while the product is in use.
 - ▶ Electrical shock can damage the product.
20. As long as this unit is connected to the AC wall outlet, it is not disconnected from the AC power source even if the unit is turned off.
21. Do not remove ground prong from three-pronged plugs. If your outlet will not accept three-pronged plugs, consult an electrician for replacement.
22. Do not block any ventilation openings. Install in accordance with the manufacturer’s instructions
23. This is a Class A digital device

CAUTION
RISK OF ELECTRIC SHOCK
DO NOT OPEN



CAUTION : TO REDUCE THE RISK OF ELECTRIC SHOCK, DO NOT REMOVE COVER (OR BACK). NO USER-SERVICEABLE PARTS INSIDE. REFER SERVICING TO QUALIFIED SERVICE PERSONNEL.

Thank You for Purchasing a DN46HE display

This manual describes how to use the product and provides safety guidelines and best practices. Please read the manual carefully before installing or using the product. After reading this manual, please retain for future reference. If you have any questions or a problem occurs, please contact either the company you purchased this product from, or an authorized service center.

- ✓ **Displaying static images for an extended period of time may cause a “burn-in” effect.**
- ✓ **“Burn-in” effect and the faults in brightness and picture elements caused by extended display of static images are not subject to warranty coverage.**

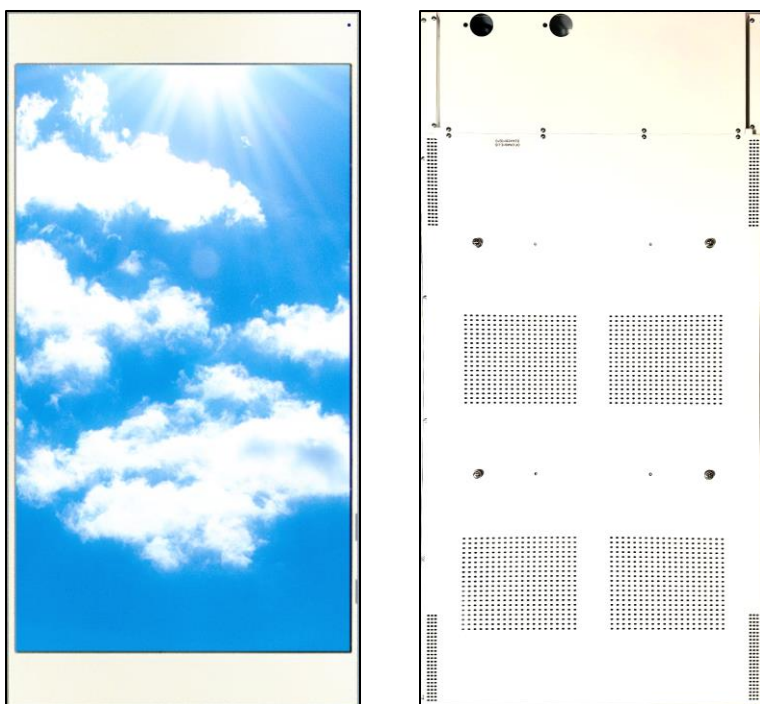

Accessories



User Manual &
Wall control program



Remote
Controller



Batteries
(AAA x 2)



RS232C Cable



Power Cable

Handling Precautions

To ensure safety, please read this manual carefully before installation and follow the instructions herein. Store this installation guide in a secure place for future reference.

- The Virtual Skylight Display must be installed on a flat and level surface which is strong enough to bear its weight.
- Make sure mounting brackets are tightened and secured on the wall
- The Liquid Crystal Display (LCD) panel of the display has a very thin protective layer of coating which is susceptible to marking or scratching, and cracking if struck or pressured. Please cover and protect the displays if there is construction or other work being conducted at the installation site.
- Transport and handle displays by holding the handles on the back of the display. Do not touch the LCD panel surface directly to avoid possible scratches and backlight leakage

Notes on handling/transporting displays:

LCD Virtual Skylight Display has limited mechanical strength. To prevent the display from performance failure caused by line defects, front bezel bending, glass scratch/broken, light leakage, etc, it must be handled with care.

- Always move the display by at least two (2) adults.
- Retain the original shipping box and packaging in storage for use in the future, when you may need to transport the product.
- When placing the display face (panel side) down:
 - Prepare a flat, level, horizontal surface that is larger than the display and spread a thick protective sheet/foam on it. (Fig. 1) – Lay the display down gently and horizontally.
- When you want to place the display in an upright position:
 - Lift the display up horizontally by holding the two (2) handles at the top/rear with one hand per person and supporting the bottom bezel with the remaining hand. **Do not allow the display to rest/put weight on bezel edges and corners**
 - Be careful not to scratch any parts of the display when placing the display upright. (Fig. 3)
 - Stand the display vertically to make sure the its weight spread evenly throughout the bottom bezel.
- * Do not rest on corners or lean forward/back. (Fig.4)

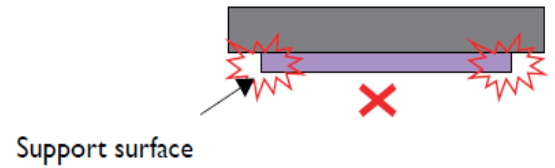

[Fig. 1]

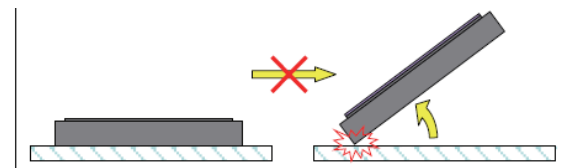

[Fig. 2]

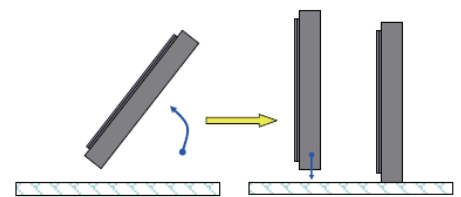

[Fig. 3]

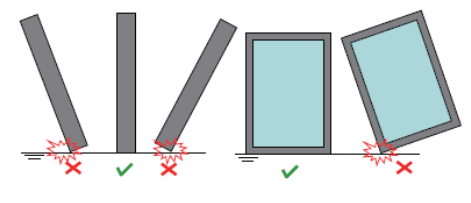

[Fig. 4]

Set up for Operation

To Install in a Portrait Layout

When installing in a Portrait Layout, rotate the monitor clockwise 90 degrees (when facing the screen)..

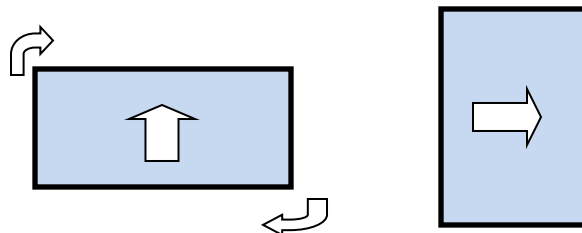

Input / Output Terminal

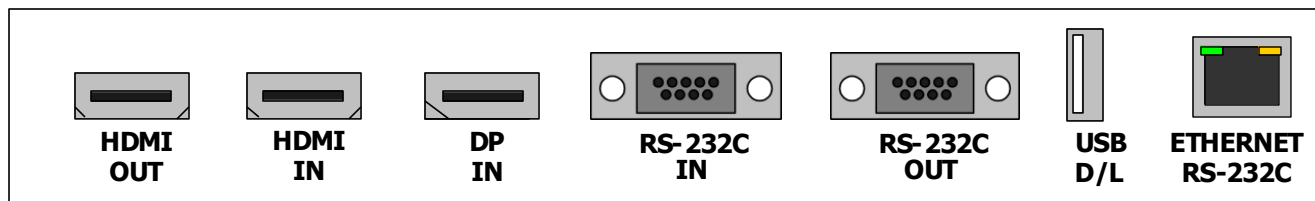

Interface	Description
HDMIOUT	• High Definition Output – only output for the HDMI input.
HDMI IN	• High Definition Multimedia Input – up to 3840x2160@60Hz (HDMI 2.0)
DP IN	• DisplayPort Input – up to 3840x2160@60Hz (v1.2a)
RS-232 IN	• Facility to control the screen via RS232 protocol Input
RS-232 OUT	• Facility to control the screen via RS232 protocol Output - Please control by using SET ID
USB	• Download - software update (Not available/active for DN46HE Model)
ETHERNET (RS-232)	• RS-232C Communication Port via the Ethernet

Set Up for Operation

Key Pad

The image may be different according to the model.

Button Name	Operation
PowerKey	▶ PowerOn/Off.
Menu Key	▶ Activates main OSD menu. ▶ Navigates higher menu in main OSD menu. ▶ Stops auto-frequency searching. ▶ Exits OSD menu.
Select Key	▶ Activates OSD menu of input source selection. ▶ Changes input source ▶ Executes functions (by OSD help commands) in main OSD menu.
Up Key	▶ Increases program number & tune channel. ▶ Navigates input source. ▶ Executes function (by OSD help commands) in main OSD menu. ▶ Navigates previous menu in main OSD menu.
Down Key	▶ Decreases program number & tune channel. ▶ Navigates input source. ▶ Executes function (by OSD help commands) in main OSD menu. ▶ Navigates next menu in main OSD menu.
Left Key	▶ Decreases sound volume of speaker. ▶ Executes function (by OSD help commands) in main OSD menu. ▶ Decreases values of user menu in main OSD menu.
Right Key	▶ Increases sound volume of speaker. ▶ Executes function by OSD help commands in main OSD menu. ▶ Increases values of user menu in main OSD menu.

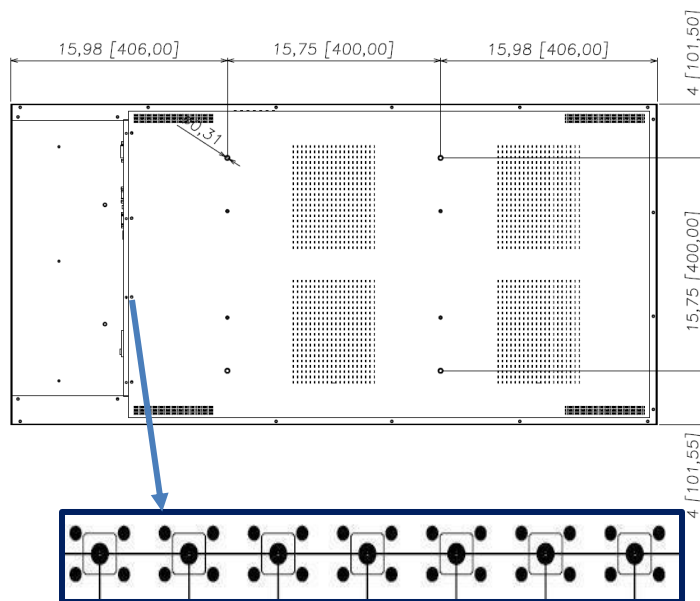

IR LED Status

Status	Color	Status
Power Off	Red	On
Normal	Green	On
No signal	Green	Blink
DPMS	Red	Blink
Download	Green	Fast Blink

GPO Display's Virtual Skylight Displays have a built-in video wall processor that allows for virtually any matrix size of LCD Virtual Skylight Display. In this manual, instructions for a 2x2 configuration will be used as an example.

1. Installation

To install DN46HE displays in Virtual Skylight Display configuration, please read the installation directions carefully before installation is performed. These monitors can be installed for single display/"standalone" operation, in a single row, or in multiple rows. The highest Display Sequence number is 99. Contact GPO Display for arrays comprised of more than 99 displays.

CAUTION: Never connect or disconnect cable to the display when the display is powered on as this may cause serious damage.

2. Installation Requirement

2.1 Structure for the installation

The structure design and construction for the display installation is the customer's or its installer's responsibility. GPO Display does not take any responsibility on design or construction of installations. The minimum requirements for space, strength of the structure, electronic, heat dissipation and environmental condition is described in the following. If any further information or support is needed from GPO Display, please contact us in advance to ensure ample time for support. We will be glad to help with any recommendations or information. Call 510-659-9855 or e-mail support@gpodisplay.com.

2.2 Power Requirements

Please refer to the specifications for power consumption of displays to be installed.

Do not plug more than two units into a given receptacle (example: displays in 2x2 video wall should not be plugged into quad receptacle). Using more than 70% of current on the AC circuit is strongly discouraged. Clean AC power is required for "noiseless" screen images. Avoid damages inflicted by power glitches or surges- either a power conditioner or surge protector is recommended. Contact your electric power specialist for consultation.

3. Heat Dissipation

This display is rated for the following operational conditions:

- Temperature: 32°F -104°F Humidity : 20-80%

4. General Information

1.1 PC Settings:

The PC needs to be set to an appropriate graphics mode that has the same resolution as the panel to have clear screen image. And the vertical refresh rate should be set to one of 56~75Hz, non-interlaced signal. The controller has been designed to take a very wide range of input signals. However, to optimize the PC's graphic performance we recommend choosing 60Hz vertical refresh rate: this will mitigate screen flicker. If you want to view 4k2k@60Hz resolution, must use a PC that supports HDMI 2.0 (or DisplayPort 1.2).

1.2 Signal Quality

Signal quality is very important: If there is noise or instability in the PC graphics output, this may result in visible noise on the display. Refer to the graphic modes table in specification section for supported modes. Non-interlaced & interlaced video input is acceptable. Please use the HDMI 2.0 dedicated cable. (4K2K@60Hz)

Set Up for Operation

Note.

- If you turn the monitor on when the set is cold, the screen may flicker. This is normal.
- Sometimes red, green, or blue spots may appear on the screen. This is normal.
- Use a High Speed HDMI®/TM cable.
- Use a certified cable with the HDMI logo attached. If you do not use a certified HDMI cable, the screen may not display or a connection error may occur
- Recommended HDMI Cable Types
 - High-Speed HDMI®/TM Cable
 - High-Speed HDMI®/TM Cable with Ethernet
- Connect the signal input cable and tighten it by turning any associated locking clockwise.
- Avoid displaying static images on the screen for a long period of time to prevent image retention/burn-in. Use a screensaver if possible.
- If you cannot hear any sound in HDMI mode, check your PC settings. Some PCs require you to manually change the default audio output to HDMI.
- Apple computers may require an adapter to connect to this monitor. Call or visit their web site for more information.

CAUTION

- Connect the signal input cable and tighten it by turning any associated locking screws clockwise.
- Do not press the screen with your finger for a prolonged period as this may result in temporary distortion on the screen
- A wireless communication device near your monitor can affect the image.

Set Up for Operation

Do not Cover Ventilation Areas.

Carefully install DN46HE so as to avoid covering/obstructing the fan air holes.

If the holes are covered and airflow is obstructed, internal temperature will rise rapidly, potentially causing malfunction. Do not cover ventilation areas.

 Ventilation

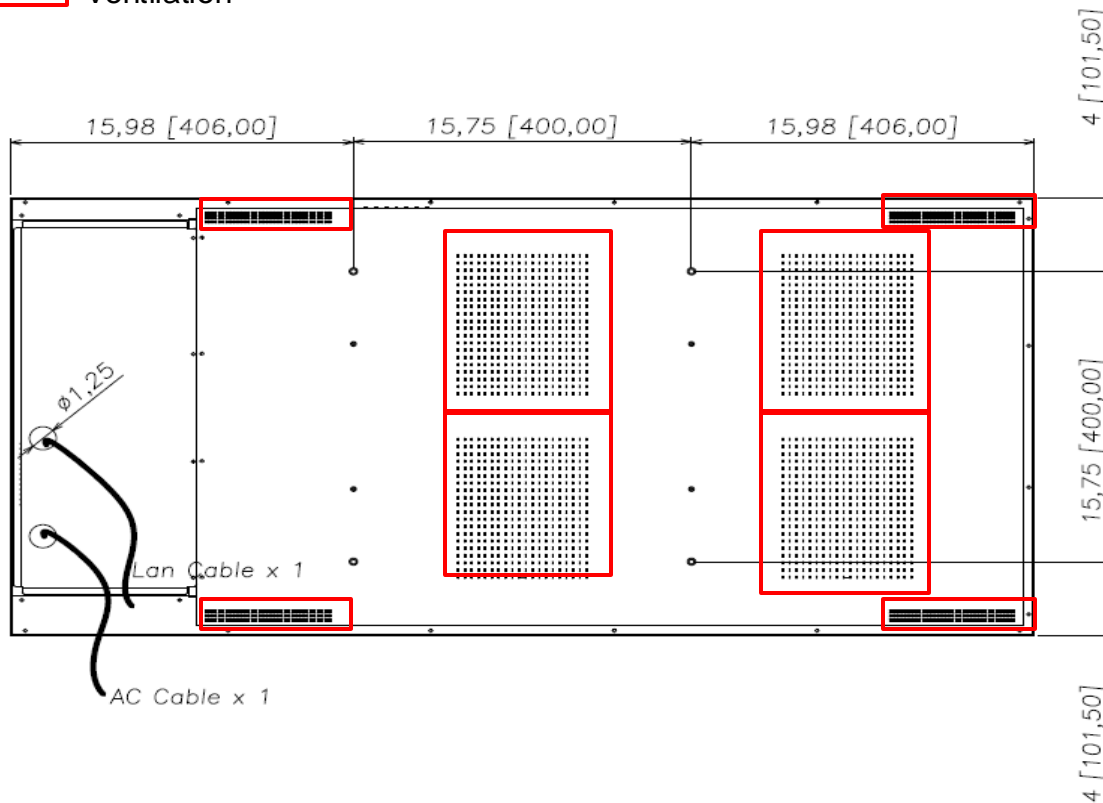

Note: This display is intended for use in ceiling-mounted applications with the LCD panel facing downward. Ventilation is specifically designed for this type of mounting. Consult with GPO Display in cases where the display will not be placed in a downward-facing mount position in a ceiling. Refer to Premier PBM-UNI mount (or equivalent). instructions

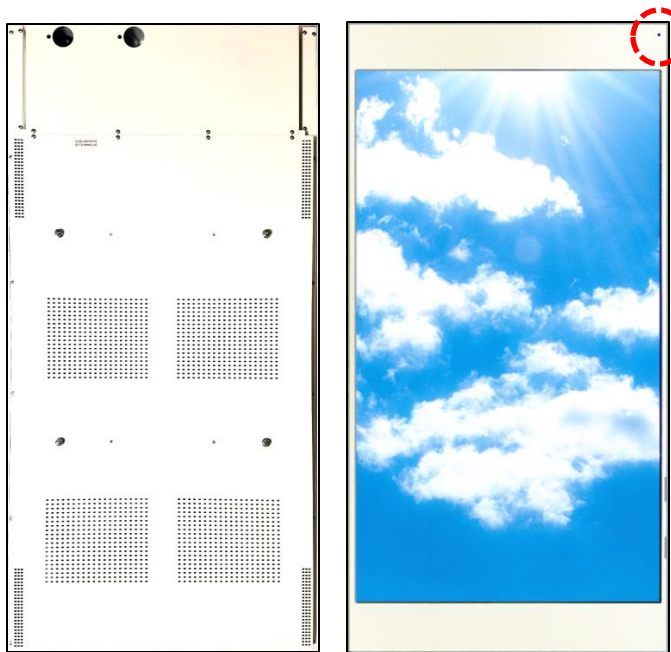

Quick Overview

- Front facing IR remote sensor.
- Internal AC outlets for media player and display .
- Two sets of mounting holes for media players within the DN46HE.
- Cable pass-through for power and LAN cable.

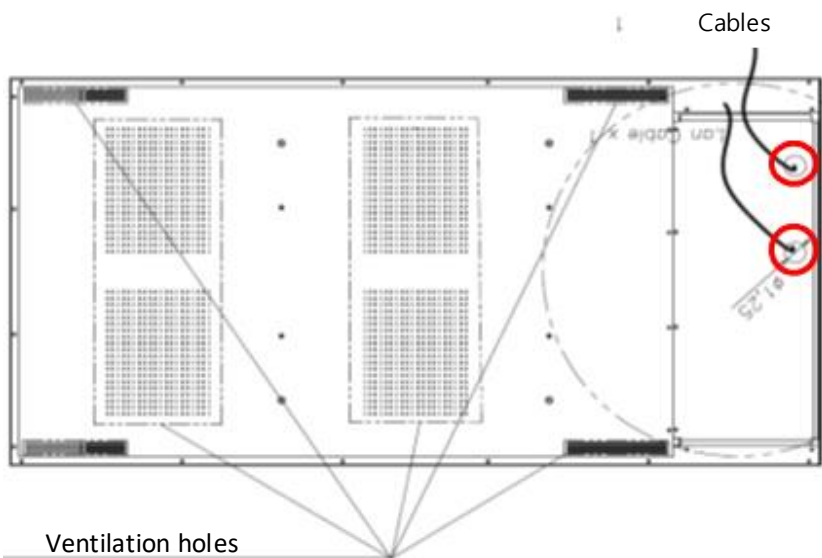

Cable and Media Player Housing Cover

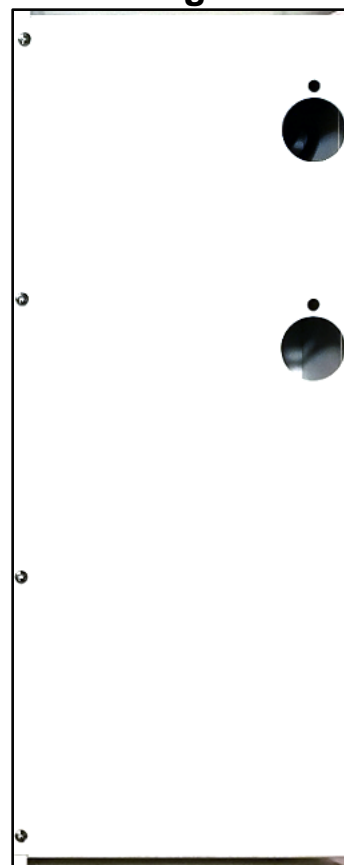
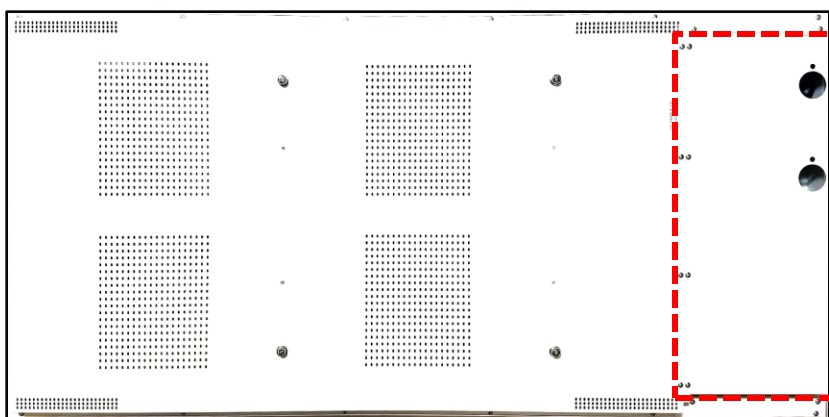

Media Player Installation Quick Guide



- Place foam padding or blanket on a table. Make sure the surface is clean and free of any small fragments or particles. This will ensure that the LCD panel is not scratched or damaged when the display is placed face-down.
- Be sure to wear anti static gloves before assembly.

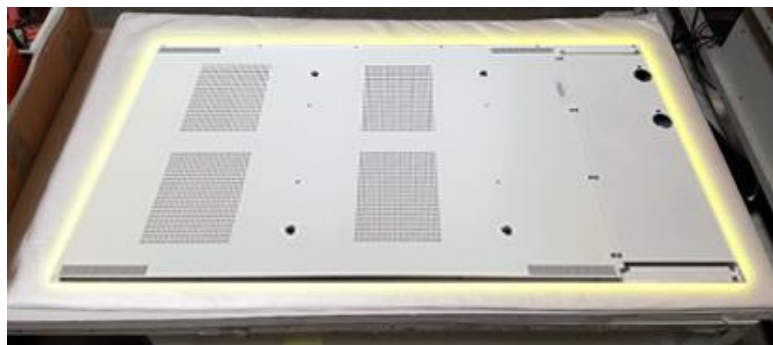

- Carefully and gradually place the display face-down on the blanket or foam. Use the handles when doing
*Avoid placing pressure on the front edge of the bezels.

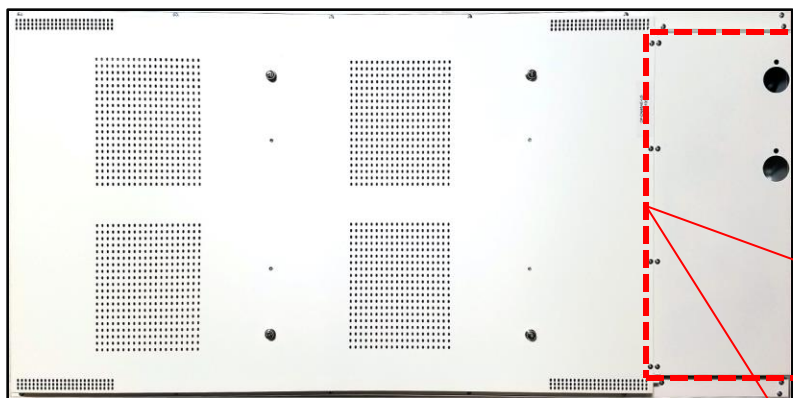

To install media player, remove the cable housing.

- Remove the screws around the perimeter of the cable housing cover. There are twelve (12) screws in total. These can be found in the area shown in the red dotted lines to the left.





- Remove the cable housing cover from the open-frame. Be careful of the cord underneath. Flip the cover upside down.



- Both the media player and the display use the internal AC outlets (outlined in blue).
- There are two sets of mounting holes (outlined in green), which will allow for the mounting of a majority of media players within DN46HE. If an alternative media player with a different mounting pattern from those provided below is desired, ask GPO Display for the desired mounting pattern.

Media Player Installation Quick Guide



- Install your media player in the cable and media housing cover and connect cabling to the DN46HE display.

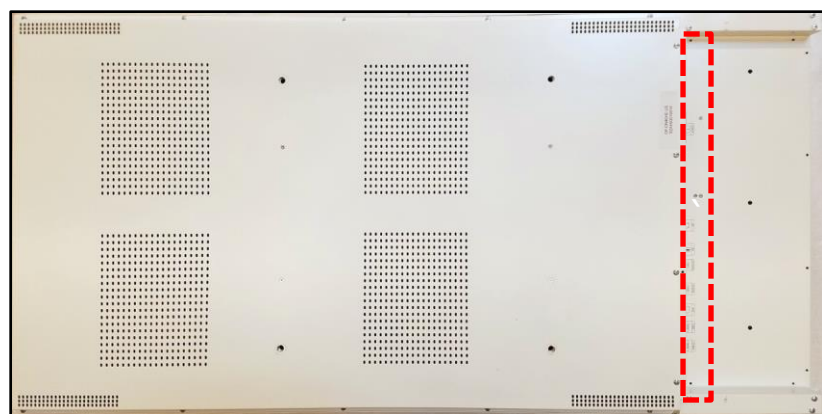

- Inputs and outputs located along the side, within the cable and media housing.

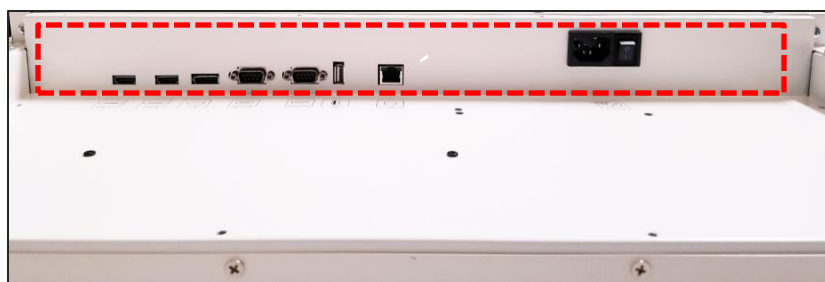
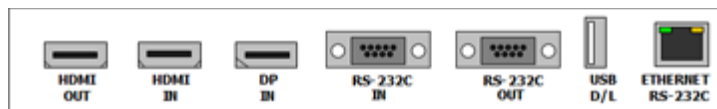

- Connect cables in the input and outputs from the media player to the DN46HE display.
- Connect AC power cable from the DN46HE display and media player to the internal AC outlets.

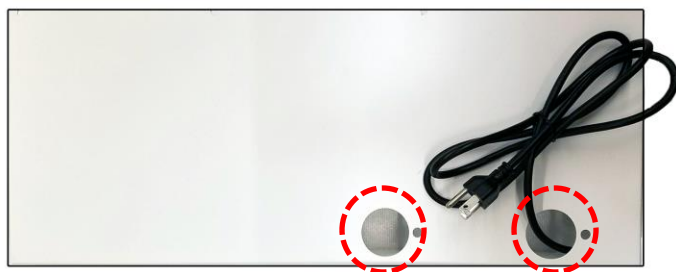

- Run the LAN cable and internal AC outlet cord through the cable pass-through holes.
- Screw the cable housing/media player cover back on to the display.

Daisy Chain Virtual Skylight Displays

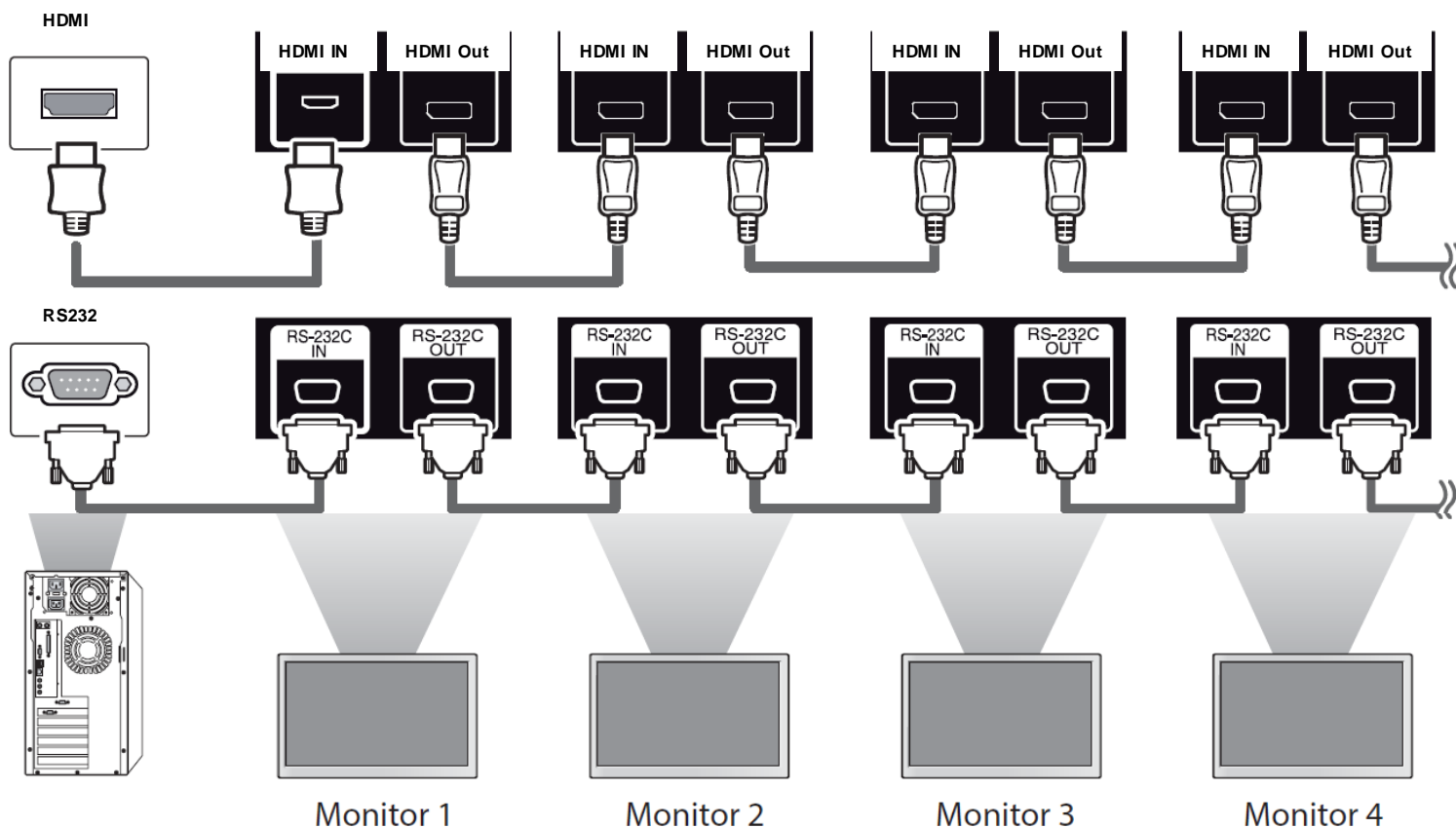

Note.

- If the signal cable between the product and your PC is too long, make sure to use signal amplification or optical cable.

Cabling Set up

Connect RS232 Cables

1. While mounting display, insert any cables used for Power, video inputs or outputs into the set.
2. Prior to insertion of the next set into neighboring Wall Unit, insert cables (including RS-232) from the outputs of the first set into the inputs of the second set.
3. Repeat steps 1-2 for next set, if necessary.
4. The RS-232 daisy chain limitation is listed as 30 displays, although theoretically more units can be accommodated.
5. Daisy-chaining can be initiated from any unit. There is no terminator at the end of the unit. It is always recommended to record/make note of the chaining diagram as it is crucial to determining issues with communication.

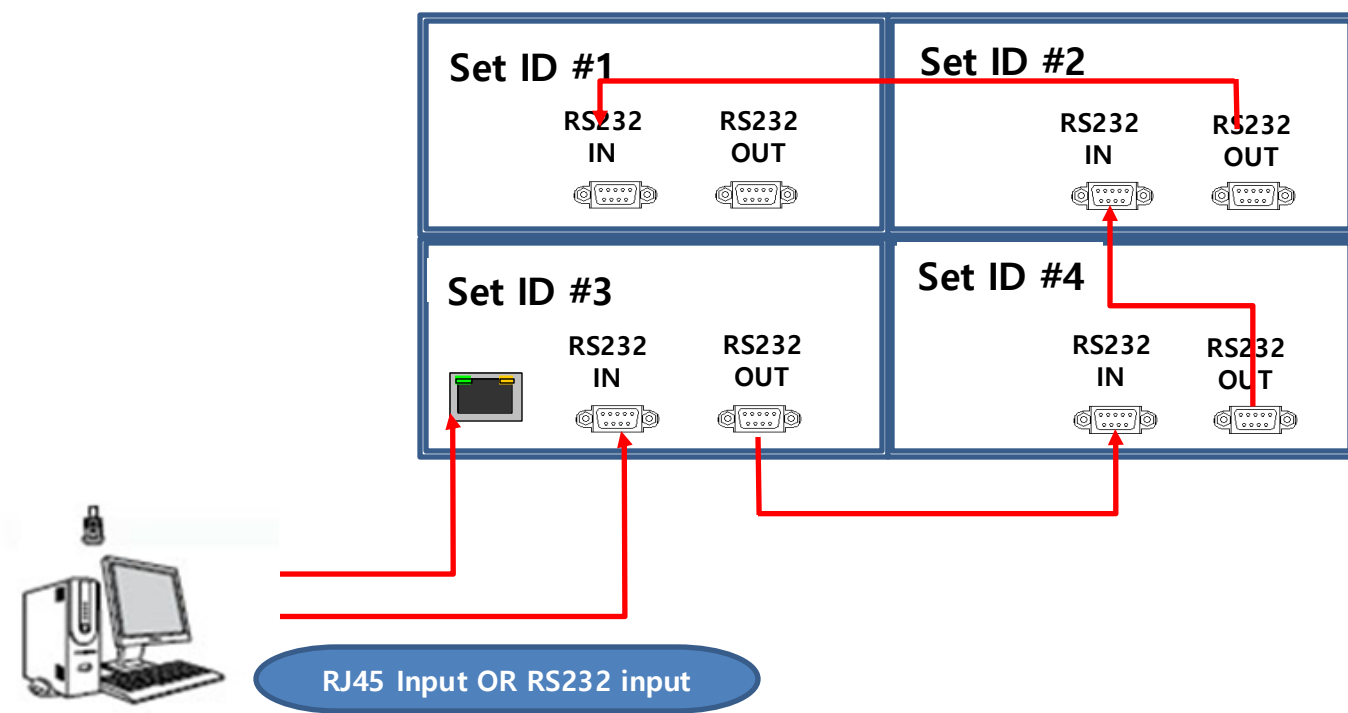

Connect Video Cables

1. After mounting display, insert any cables used for Power, inputs or outputs into the set.
2. Prior to insertion of the next set into neighboring mount, insert cables from the outputs of the first set into the inputs of the second set.
3. Insert any cables which are to be connected to the third set into the outputs of the second set. Connect these cables into the inputs of the third set.
4. Repeat steps 1-3 for fourth set, if necessary.

- Supports HDMI 4Kx2K input – HDMI, DP only
- Supports the daisy-chaining of 4k2k resolution. (Only HDMI input)
- Recommended HDMI Cable Types
 - High-Speed HDMI®/TM Cable
 - High-Speed HDMI®/TM Cable with Ethernet
- Some installation sites have a high level of electric noise which may appear onscreen, especially with HDMI.
- Digital noise may appear due to poor quality HDMI cabling. If the video signal needs be delivered from a distance, electric noise must be accounted for. If the signal cable between the product and your PC is too long, make sure to use the Booster or optical cable.
- HDMI and DisplayPort are HDCP-compliant.
 - HDCP 2.2 Compliant HDMI 2.0 Compliant Display Port v1.2a Compliant
- **Signal-looping specifications (Only HDMI input / DP port doesn't support daisy-chain function)**

Input Resolution	SPEC	Remarks
3840x2160@60Hz	Supports up to 9 units.	Use only HDMI 2.0 cable.
3840x2160@30Hz	Supports up to 16 units.	Daisy-chaining with this timing is not recommended
1920x1080@60Hz	Supports up to 25 units.	

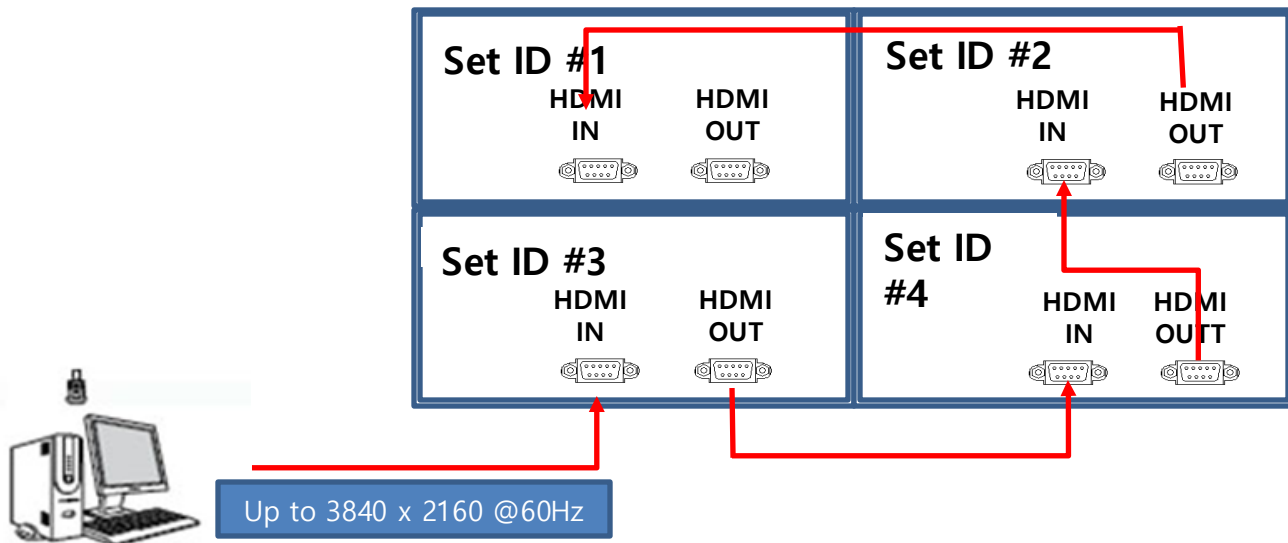

Virtual Skylight Display Setting

MENU → Virtual Skylight Display

X max

This function automatically divides the screen according to the specified number of horizontal displays. Enter the number of horizontally arranged displays. The horizontal screen will automatically be divided according to the number entered. A maximum of 10 displays can be assigned to the horizontal arrangement.

Y max

This function automatically divides the screen according to the specified number of vertical displays. Enter the number of vertically arranged displays. The vertical screen will automatically be divided according to the number entered. A maximum of 10 displays can be assigned to the vertical arrangement.

X position / Y position

You can customize the arrangement of split screens by moving displays identified with a number using the X Position / Y Position function. Select X / Y Position to display the arrangement of displays (identified with a number) specified according to the Horizontal or Vertical settings. To customize the arrangement, move a number (display) using the direction buttons on the remote control and press

Example. 3 X 3 Videowall layout setting

Picture	X MAX	1
Color	Y MAX	1
Video Wall	X Position	1
PC-RGB	Y Position	1
Audio	X Gap	0
Heat Control	Y Gap	0
Network	Set ID	11
Timer		
Other Setting		

Set ID: 1 X max: 3 Y max: 3 X position: 1 Y position: 1	Set ID: 2 X max: 3 Y max: 3 X position: 2 Y position: 1	Set ID: 3 X max: 3 Y max: 3 X position: 3 Y position: 1
Set ID: 4 X max: 3 Y max: 3 X position: 1 Y position: 2	Set ID: 5 X max: 3 Y max: 3 X position: 2 Y position: 2	Set ID: 6 X max: 3 Y max: 3 X position: 3 Y position: 2
Set ID: 7 X max: 3 Y max: 3 X position: 1 Y position: 3	Set ID: 8 X max: 3 Y max: 3 X position: 2 Y position: 3	Set ID: 9 X max: 3 Y max: 3 X position: 3 Y position: 3

X Max : Maximum number of column tiles to divide video image. (Support up to 10step)

Y Max : Maximum number of row tiles to divide video image. (Support up to 10step)

X position : Coordinate of video image's column position.

Y position : Coordinate of video image's row position.

Virtual Skylight Display Setting

Full Mode / Natural Mode

MENU → Virtual Skylight Display

Full Mode: X gap: 0 / Y gap: 0

Natural Mode

Setting the Bezel Corrections for Natural Tiled Image

X gap: Setting Value = (int)(1000xGap/Active)

Example) 55" UNB Virtual Skylight Display

- Horizontal Active: 1,209.6 mm

- Horizontal GAP: 3.5 mm

Setting Value = (int) ((1,000 x 3.5)/1,209.6) = (int)2.89 = 3

Y gap: Setting Value = (int) ((1,000 x Gap)/Active)

Example) 55" UNB Virtual Skylight Display

- Horizontal Active: 1,209.6 mm

- Horizontal GAP: 3.5 mm

Setting Value = (int) ((1,000 x 3.5)/1,209.6) = (int)2.89 = 3

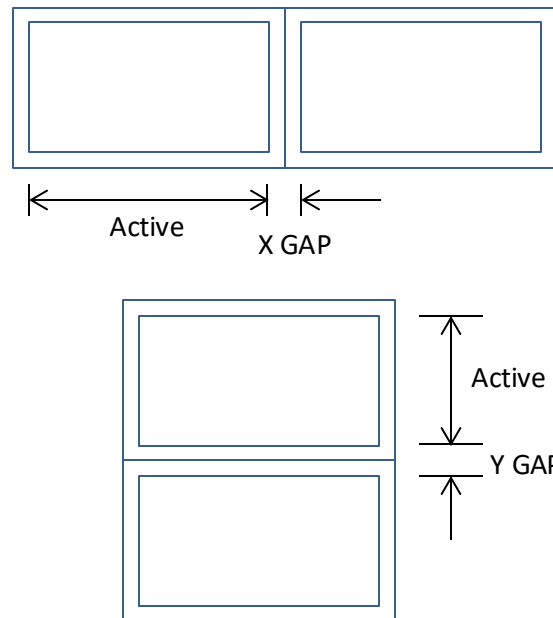

Auto switch Video Input color Format

MENU → Input Color Format → Auto Select

Turning on the display with **Input color format Auto On**, and the previous video source selection is not active, the display will automatically search the different video input sources for active video.

Check the color space of the input signal, to adjust the screen. [RGB / YPbPr422 (YPbPr444)]

Picture	Color Temperature	RGB
Color	Red Gain	YPbPr
Video Wall	Green Gain	Auto Select
PC-RGB	Blue Gain	
Audio	Gamma	
Heat Control	Input Color Format	
Network	Color Range	
Timer		
Other Setting		

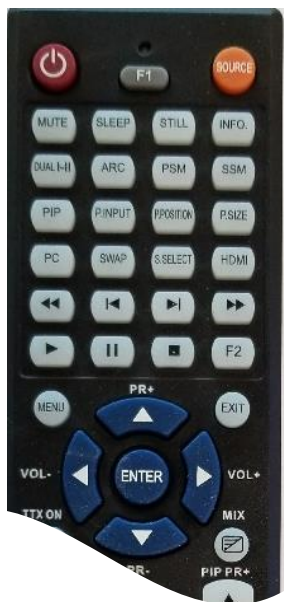

1. SOURCE : Selects Input Source
2. POWER : Turns the LCD Display On and Off
3. UP : Controls the UP cursor in the menu
4. LEFT : Controls the LEFT cursor in the menu
5. RIGHT : Controls the RIGHT cursor in the menu
6. ENTER : Controls the ENTER cursor in the menu
7. DOWN : Controls the DOWN cursor in the menu
8. MENU : Displays the main On-Screen menu
9. EXIT : Exit the On-Screen menu

Key Name	Description
Power	▶ Power On/Off
Menu	▶ Same as "Menu key" on keypad.
Up	▶ Same as "Up key" on keypad
Down	▶ Same as "Down key" on keypad
Right	▶ Same as "Right key" on keypad
Left	▶ Same as "Left key" on keypad
Enter	▶ Same as "Select key" on keypad
EXIT	▶ Exit OSD menu
Info	▶ Displays input source information
Sleep	▶ Set minimum sleep timer value more than current sleep timer value when sleep timer OSD activated ▶ If sleep timer is maximum value, disables sleep timer
Mute	▶ Toggles sound status of speaker/headphone in mute.
Source	▶ Activates OSD of source change. ▶ Deactivates OSD of source change.
ARC	▶ Activates OSD of aspect ratio control. ▶ Deactivates OSD of aspect ratio control.
STILL	▶ Toggles picture status between motion and still image.
0~9	▶ Enter digit value to Active SET ID
BLUE	▶ Set Active SET ID
RED	▶ Delete Active SET ID

OSD Menu

Most menus consist of three levels to set up the options, but some require greater depth for the variety of settings. If you press the MENU button, up to the third level of the menu system will appear on the monitor screen. The fourth level can be displayed by pressing OK button

- To show and remove the Menu:
 - Press the MENU button on the Remote Control to display the menu. A second press of the MENU button or a press of the EXIT button will take you back to monitor viewing.
- To go to the next level:
 - Press OK (or Right arrow button) on the Remote Control.
- To go back to the previous level:
 - Press MENU (or Left arrow button) on the Remote Control.
- To go to the next menu:
 - Press Down arrow button on the Remote Control.
- To go to the previous menu:
 - Press Up arrow button on the Remote Control

To set Input Source

source : Display Port, HDMI (HD-SDI : Optional)

Source → Input Source

To use, press the source key and the arrow Keys to select each video source. Press the OK button to go to desired video source

(HD-SDI is not available for DN46HE model)

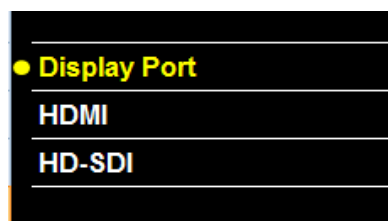

To fine-tune the picture mode Contrast / Brightness /Sharpness

Adjust the picture appearance to suit your preference and viewing situations.

Picture → Contrast Brightness or Sharpness → Adjustment

Press the MENU button to select the **PICTURE** mode

Press the OK button or arrow key to select **Contrast** menu.

Press the OK key or arrow key to select Adjustment menu.

Press the arrow key to make appropriate adjustments.

Press MENU key or arrow key to return to the previous menu.

Or, in order to come out at any time, press the EXIT key.

- Brightness: adjusts the overall brightness of the screen
- Contrast: adjusts the difference between the light and dark areas of the picture.
- Sharpness: adjusts the sharpness of the edges of objects

Picture	Contrast	50
Color	Brightness	50
Video Wall	Sharpness	50
PC-RGB	Hue/Saturation	
Audio	Aspect Ratio	Full Screen
Heat Control	Auto Dimming Mode	Off
Network	Dimming	100
Timer	Max Ambient	300
Other Setting	Min Ambient	100
	Ambient	0

To set Aspect Ratio

Changes the aspect ratio to view the image in its optimal size.

[Picture](#) → [Aspect Ratio](#) → [Adjustment](#)

Press the MENU button to select the **PICTURE** mode.

Press the OK button or arrow key and then select **Aspect Ratio** menu.

[[Full Screen](#), [Auto](#), [4:3](#), [5:4](#), [16:9](#), [1:1](#)]

Picture	Contrast	Full Screen
Color	Brightness	Auto
Video Wall	Sharpness	4:3
PC-RGB	Hue/Saturation	5:4
Audio	Aspect Ratio	16:9
Heat Control	Auto Dimming Mode	1:1
Network	Dimming	
Timer	Max Ambient	
Other Setting	Min Ambient	
	Ambient	

To use Auto Dimming function

Automatic dimming controls by light sensor in Dimming menu

(Only applies to certain models)

[Picture](#) → [Auto Dimming Mode](#) → [Adjustment](#)

- Off : Adjust the dimming level by the manual operation.
- On : Adjust the dimming level by the data of light sensor. (Light Ambient Sensor Option only)
- ECO : Adjust the dimming level of 50.

Picture	Contrast	Off
Color	Brightness	On
Video Wall	Sharpness	ECO
PC-RGB	Hue/Saturation	
Audio	Aspect Ratio	
Heat Control	Auto Dimming Mode	
Network	Dimming	
Timer	Max Ambient	
Other Setting	Min Ambient	
	Ambient	

To set Dimming

Manually adjust the brightness of the screen.

(Auto Dimming Mode – Off / Only applies to certain models)

[Picture](#) → [Dimming](#) → [Adjustment](#)

Picture	Contrast	50
Color	Brightness	50
Video Wall	Sharpness	20
PC-RGB	Hue/Saturation	
Audio	Aspect Ratio	Full Screen
Heat Control	Auto Dimming Mode	Off
Network	Dimming	100 
Timer	Max Ambient	300
Other Setting	Min Ambient	100
	Ambient	0

To adjust Gamma

Adjust the color on the screen

Color → Gamma → Adjustment

Select Desired option [2.0, 2.2, 2.35, 2.4, 2.6]

Do not adjust gamma without consulting with GPO Display first. This may compromise color uniformity/calibration.

Picture	Color Temperature	User
Color	Red Gain	255 
Video Wall	Green Gain	255
PC-RGB	Blue Gain	255
Audio	Gamma	2.2
Heat Control	Input Color Format	Auto Select
Network	Color Range	Auto Select
Timer		
Other Setting		

To Set Input Color Format

Check the color space of the input signal
[RGB / YPbPr422 / YPbPr444]

Color → Input Color Format → Adjustment

[RGB, YPbPr, Auto Select]

Picture	Color Temperature	RGB
Color	Red Gain	YPbPr
Video Wall	Green Gain	Auto Select
PC-RGB	Blue Gain	
Audio	Gamma	
Heat Control	Input Color Format	
Network	Color Range	
Timer		
Other Setting		

To set Color Range

Check the color space of the input signal, to adjust the screen. [0~255, 16~235]

Color → Color Range → Adjustment

This function is internally automatically converted, please do not be adjusted without special reason

[Auto Select, 0-255, 16-235]

Picture	Color Temperature	Auto Select
Color	Red Gain	0-255
Video Wall	Green Gain	16-235
PC-RGB	Blue Gain	
Audio	Gamma	
Heat Control	Input Color Format	
Network	Color Range	
Timer		
Other Setting		

To Heat Control Setting – Heat Control

Heat Control → Fan active Temperature → Adjustment

Heat Control → Hysteresis → Adjustment

Heat Control → Shutdown → Adjustment

- Fan Active Temperature : Adjusts fan driving temperature by Celsius degree. It works only when the Fan Control setting is Auto.
- Hysteresis : Variable range of Fans on/off interval.
- Shutdown : Adjust shutdown mode temperature by Celsius degree. when current temperature reaches the shutdown temp, the monitor enters power down mode.
- Temperature : The internal temperature data by the temperature sensor.

Network Setting

Network → Network → Adjustment

- Disable : Communication connection via a DSUB-9P of Board without the use of a network.
- Enable : Communication connection using a network

Network Setting-Load Network Setting

Network → Load Network Setting → Adjustment

- Enter : Get the network information that is stored in the LAN board

Picture	Fan Control	Auto
Color	Fan Active Temperature	50.0°C
Video Wall	Hysteresis	2.0°C
PC-RGB	Shutdown	85.0°C
Audio	Temperature	37.0°C
Heat Control		
Network		
Timer		
Other Setting		

Picture	Network	Disable
Color	Load Network Setting	Enable
Video Wall	DHCP	
PC-RGB	IP Address	
Audio	Gateway	
Heat Control	Subnet	
Network	Save Current Setting	
Timer		
Other Setting		

Picture	Network	Enter
Color	Load Network Setting	
Video Wall	DHCP	
PC-RGB	IP Address	
Audio	Gateway	
Heat Control	Subnet	
Network	Save Current Setting	
Timer		
Other Setting		

Network Setting - DHCP

Network → DHCP → Adjustment

- **On:** Gather IP information of monitor from the Server. (to avoid IP address conflicts.)
- **Off:** User may enter IP address manually using the video wall control program (see p. 35 of this document for more detail).
- Note that when “Network” is set to “Enable”, serial communication will be disabled. When “Network” is set to “Disable”, you may communicate with displays via RS-232

Network Setting – Network Information

- Write down your IP Address, Gateway, and Subnet values and retain for future reference.
- The use of a static IP is strongly recommended.
- Consult with your organization’s IT specialist(s) for more info on static IP’s.

Network Setting – Save current Setting

Network → Save current setting → Adjustment

- After assigning Network info (IP Address, Gateway, Subnet), select “Save Current Setting” and then “Enter”. If you do not select “Enter”, the settings will not be saved.

Picture	Network	Enable
Color	Load Network Setting	
Video Wall	DHCP	On
PC-RGB	IP Address	174.168.10.7
Audio	Gateway	174.168.10.1
Heat Control	Subnet	255.255.255.0
Network	Save Current Setting	
Timer		
Other Setting		

Picture	Network	Enable
Color	Load Network Setting	
Video Wall	DHCP	On
PC-RGB	IP Address	174.168.10.7
Audio	Gateway	174.168.10.1
Heat Control	Subnet	255.255.255.0
Network	Save Current Setting	
Timer		
Other Setting		

Picture	Network	Enter
Color	Load Network Setting	
Video Wall	DHCP	
PC-RGB	IP Address	
Audio	Gateway	
Heat Control	Subnet	
Network	Save Current Setting	
Timer		
Other Setting		

Timmer Settings – Current Time

Timer → Current Time → Adjustment

- If current time setting is wrong, reset the clock manually
- When the AC POWER is OFF, current time will be initialized

Picture	Current Time	Hour	1
Color	On Time	Min	40
Video Wall	Off Time		
PC-RGB			
Audio			
Heat Control			
Network			
Timer			
Other Setting			

Timmer Settings – On time / Off Time

Timer → On time → Adjustment

Timer → Off time → Adjustment

- On Time : Set the time to start automatically.
- Off Time : Set the power off time automatically.

Picture	Current Time	Enable	Off
Color	On Time	Hour	0
Video Wall	Off Time	Min	0
PC-RGB			
Audio			
Heat Control			
Network			
Timer			
Other Setting			

Network Setting – Save current Setting

Network → Save current setting → Adjustment

Picture	Network	Enter
Color	Load Network Setting	
Video Wall	DHCP	
PC-RGB	IP Address	
Audio	Gateway	
Heat Control	Subnet	
Network	Save Current Setting	
Timer		
Other Setting		

OSD Menu

Other Setting – Language

Other Setting → Language → Adjustment

Picture	Language	English
Color	Menu Transparency	20
Video Wall	OSD Time	15 sec
PC-RGB	Power Save Mode	Off
Audio	Local Dimming	On
Heat Control	MFC	Off
Network	Reset	
Timer	Software Update(USB)	
Other Setting	Version	v0.02 / Jan

Other Setting – Menu Transparency

Other Setting → Menu Transparency → Adjustment

Set the OSD transparency

Picture	Language	English
Color	Menu Transparency	20
Video Wall	OSD Time	15 sec
PC-RGB	Power Save Mode	Off
Audio	Local Dimming	On
Heat Control	MFC	Off
Network	Reset	
Timer	Software Update(USB)	
Other Setting	Version	v0.02 / Jan

Other Setting – OSD Timeout

Other Setting → OSD Timeout → Adjustment

Set the screen duration time of OSD

Picture	Language	Off
Color	Menu Transparency	5 sec
Video Wall	OSD Time	10 sec
PC-RGB	Power Save Mode	15 sec
Audio	Local Dimming	20sec
Heat Control	MFC	60 sec
Network	Reset	
Timer	Software Update(USB)	
Other Setting	Version	v0.02 / Jan

OSD Menu

Other Setting – Power Save Mode

[Other Setting](#) → [Power Save Mode](#) → [Adjustment](#)

Shut off the panel power after the input source has been unused for some time, to save power

Picture	Language	On
Color	Menu Transparency	Off
Video Wall	OSD Time	
PC-RGB	Power Save Mode	
Audio	Local Dimming	
Heat Control	MFC	
Network	Reset	
Timer	Software Update(USB)	
Other Setting	Version	v0.02 / Jan

Other Setting – Local Dimming

[Other Setting](#) → [Local Dimming](#) → [Adjustment](#)

Set the Local dimming for the particular panel. (DN46HE)

Picture	Language	On
Color	Menu Transparency	Off
Video Wall	OSD Time	
PC-RGB	Power Save Mode	
Audio	Local Dimming	
Heat Control	MFC	
Network	Reset	
Timer	Software Update(USB)	
Other Setting	Version	v0.02 / Jan

Other Setting – Reset

[Other Setting](#) → [Reset](#) → [Adjustment](#)

Set the screen duration time of OSD

Picture	Language	Enter
Color	Menu Transparency	
Video Wall	OSD Time	
PC-RGB	Power Save Mode	
Audio	Local Dimming	
Heat Control	MFC	
Network	Reset	
Timer	Software Update(USB)	
Other Setting	Version	v0.02 / Jan

OSD Menu

Other Setting – Software Update

Other Setting → Software Update → Adjustment

Software update function using the USB MEMORY.

- Save the update file to a USB stick. (ex) mergy_170723.bin
- Insert the USB stick into the USB input for download.

Picture	Language	Enter
Color	Menu Transparency	
Video Wall	OSD Time	
PC-RGB	Power Save Mode	
Audio	Local Dimming	
Heat Control	MFC	
Network	Reset	
Timer	Software Update(USB)	
Other Setting	Version	v0.02 / Jan

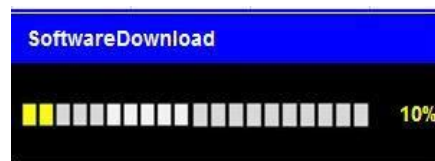

If you see the failure message to the left, please check the USB stick to ensure that it is plugged in.

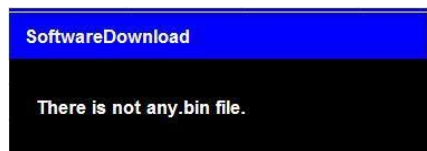

If the file for download is not in the USB stick, Please check download file.

Other Setting – Version

Other Setting → Version → Check

Check the Firmware information of the current software

Picture	Language	English
Color	Menu Transparency	20
Video Wall	OSD Time	15 sec
PC-RGB	Power Save Mode	Off
Audio	Local Dimming	On
Heat Control	MFC	Off
Network	Reset	
Timer	Software Update(USB)	
Other Setting	Version	v0.02 / Jan

To set Color Temperature

Choose one of four automatic color adjustments

Color → Color Temperature → Adjustment

- * Set to warm to enhance hotter colors such as red,
- Set to cool to see less intense colors with more blue

[5700K, 6500K, 9300K, User]

If you change the GAIN value, automatically switches to the User mode.

Picture	Color Temperature	5700K
Color	Red Gain	6500K
Video Wall	Green Gain	9300K
PC-RGB	Blue Gain	User
Audio	Gamma	
Heat Control	Input Color Format	
Network	Color Range	
Timer		
Other Setting		

No Image is displayed

Problem	Action
Is the product power cord connected?	Check if the power cord is correctly plugged into the power outlet.
Does an “out of range” message appear?	The signal from the PC (graphics card) is out of the vertical or horizontal frequency range of the product. Adjust the frequency range by referring to the Specifications in this manual.
Does the “No Signal” message appear?	The signal cable between PC and product is not connected. Check the signal cable. Press the INPUT menu in the remote Control to check the input signal.

The screen image looks abnormal.

Problem	Action
Is the screen position wrong?	Check if the graphics card resolution and frequency are supported by the product. If the frequency is out of range, set to the recommended resolution in the Control Panel DisplaySetting menu.
The screen is displayed abnormally.	The proper input signal is not connected to the signal port. Connect the signal cable that matches with the source input signal.

After-image appears on the product.

Problem	Action
After-image appears when the product is turned off.	If you use a fixed image for a long time, the pixels may be damaged. Use the screen-saver function. When a dark image is displayed on the screen after an image with high contrast (black and white or gray), this may cause image sticking. This is normal for LCD screen products.

Screen color is abnormal.

Problem	Action
Screen has poor color resolution (16 colors).	Set the number of colors to more than 24 bits (true color). Select Control Panel - Display - Settings - Color Table menu in Windows.
Screen color is unstable or mono-colored.	Check the connection status of the signal cable. Or, re-insert the PC graphics card.
Do black spots appear on the screen?	Several pixels (red, green, white, or black color) may appear on the screen, which can be attributable to the unique characteristics of the LCD panel. This is not a malfunction of the LCD.

The operation does not work normally.

Problem	Action
The power suddenly turned off.	Is the Timer set? Check the DPMS Mode Check the power control settings. Power interrupted.

CAUTION

- Image retention/burn-in/"image sticking" does not occur when using constantly changing images but may occur when using a fixed image for an extended period of time. Therefore, it is recommended that you use the instructions below to decrease the likelihood of image sticking occurring when using a fixed image. It is recommended that you change the screen at least once every **3hours** at the very minimum; if done more frequently, the prevention of image sticking is more effective.

Recommended operating conditions

- 1) Change the background and the character colors using the same time interval.
- 2) Change the image using the same time interval

What is image sticking?

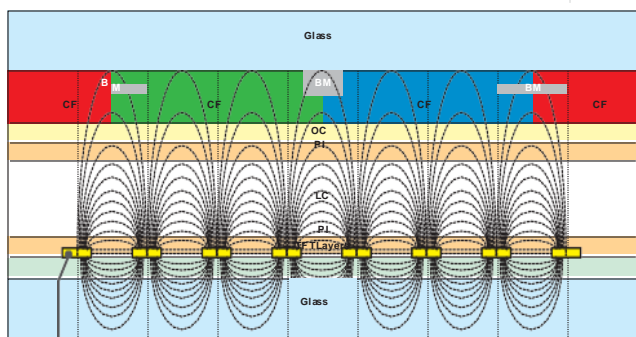

ITO or MoTi Pixel Layer

When the LCD panel displays a static image for an extended period of time, it can cause a voltage difference between the electrodes that operate the liquid crystals. When the voltage difference between the electrodes builds up over time, liquid crystals have a tendency to remain aligned in one direction. During this process, a previously displayed image remains visible. This phenomenon is referred to as image sticking.

Virtual Skylight Display Control PROGRAM

Instruction

- The program is designed to be a user friendly method for controlling a large number of monitors through RS-232C or TCP/IP interface
- Create & Edit monitor System Controller Map.
This is available to save the layout of the System Controller Map as a file format
- Control a Large Number of Monitors.
By using the Control Panel it is possible to control one or more monitors.
- Status Display
Status readouts for each Monitor can be displayed.
- System Requirements
This program only runs on Windows XP or above.
Microsoft .NET framework 4.0 or later.

How to Install program

- **Microsoft .NET Framework 4 must be installed. (or later)**
 - Double-click on the setup icon
 - Follow setup wizard instructions
 - After installation is completed, a shortcut button will be shown on the PC and in the start menu.

Running Control program and Structure

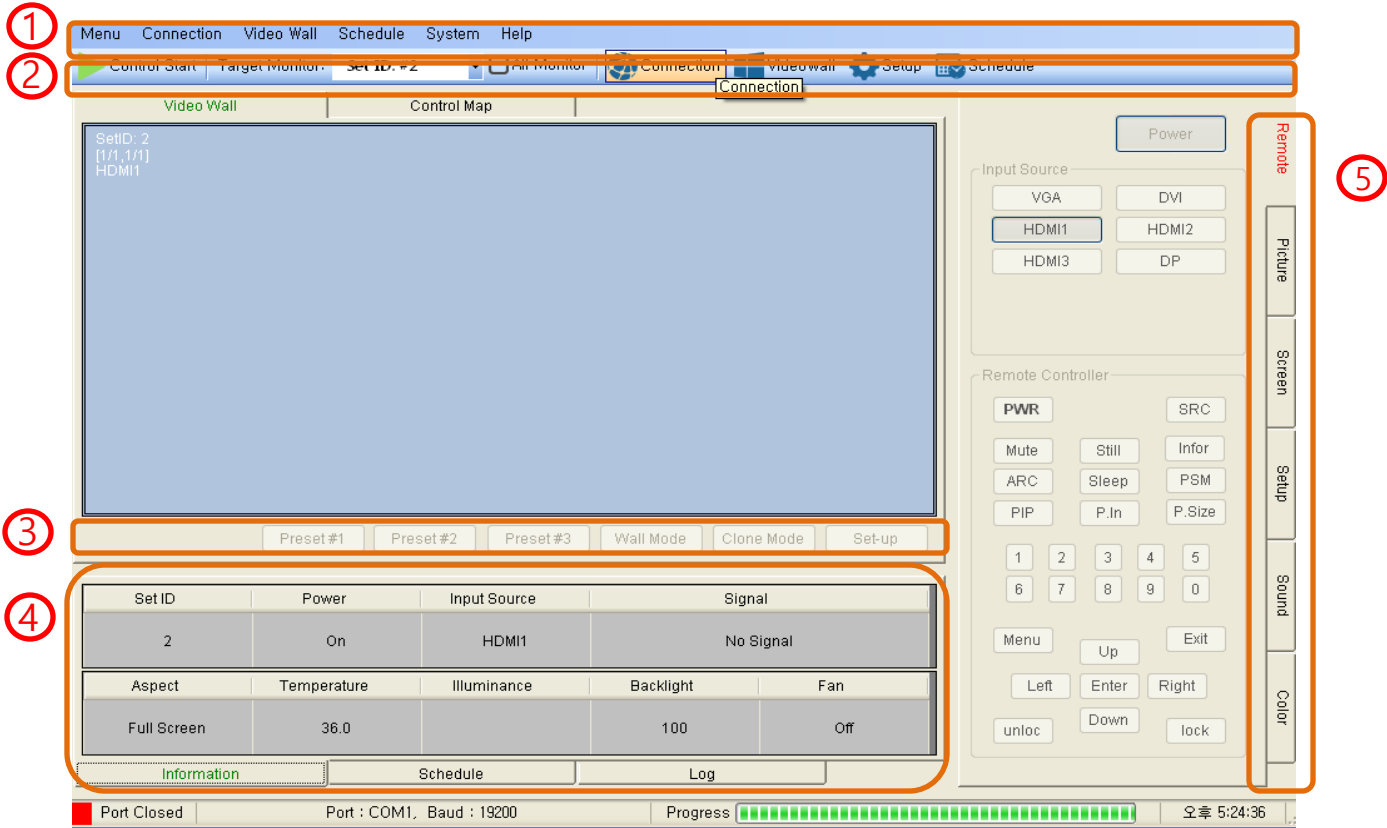

Menu Bar 1



Menu

- Save:** Saves current settings (User1, User2, User3)
- Load:** Loads saved settings (Default, User1, User2, User3)
- Save File:** Save the current setting to a file.
- Load File:** Load the file setting of a save file.

Menu Bar



Connection

Configuration: Displays the serial port and TCP/IP information

Interface: Display the selected connection method (RS232 or TCP/IP)

Com Port: Show the connected serial port (Only if the RS232 is selected will it be enabled)

Baud rate: Show the serial communication speed (Only if the RS232 is selected will it be enabled)

Host IP Address: Shows IP address of the PC where the program is running (Only if the TCP/IP selected will it be enabled)

Target IP Address: Shows IP address of the monitor (Only if the TCP/IP selected will it be enabled)

Search: Looks for the IP address of the connected monitor (See pic#1)

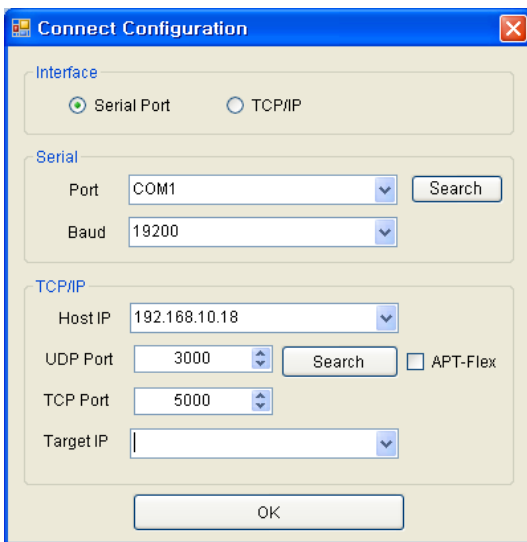

[Serial Port setting]

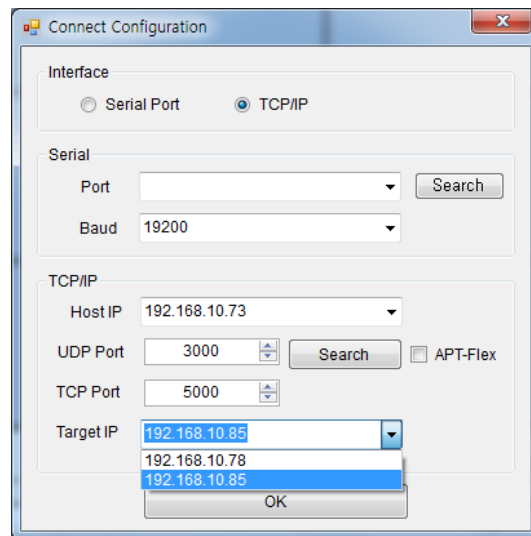

[TCP/IP setting]

Picture	Network	Enable
Color	Load Network Setting	
Video Wall	DHCP	On
PC-RGB	IP Address	174.168.10.7
Audio	Gateway	174.168.10.1
Heat Control	Subnet	255.255.255.0
Network	Save Current Setting	
Timer		
Other Setting		

[pic#1]

Menu Bar 1

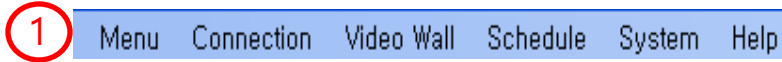

Video Wall

Configuration: Displays configuration of video wall.

Users can select the settings in single mode and multi mode

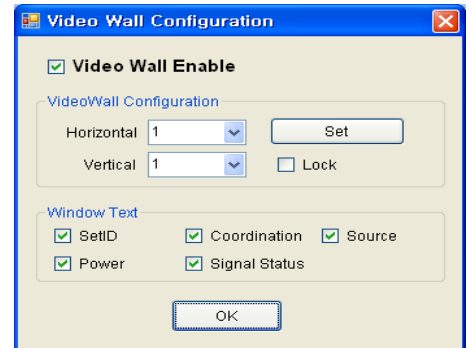

Save Preset button: Recall preset/saved video wall layouts

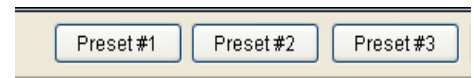

Video Wall Control

User can control multiple or all displays in a video wall array in a single operation by right-clicking (Read Status, Read All Parameters, Set Coordinate, Source, Set ID)

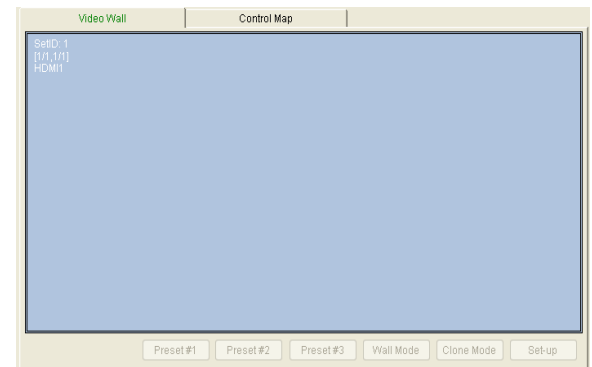

[Video Wall _ Single mode]

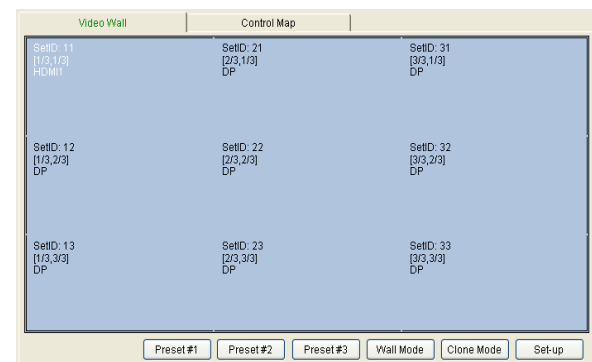

[Video Wall _ Multi mode]

Menu Bar 1

1 Menu Connection Video Wall Schedule System Help

Schedule

Users can select layouts and duration of said layouts:

- Select the monitor in the window of video wall.
- Select the input source to drive the monitor.
- Select the time to drive the monitor.
- User can make settings such as adding and removing.
- User can see the set schedule.
- Time display and control buttons display

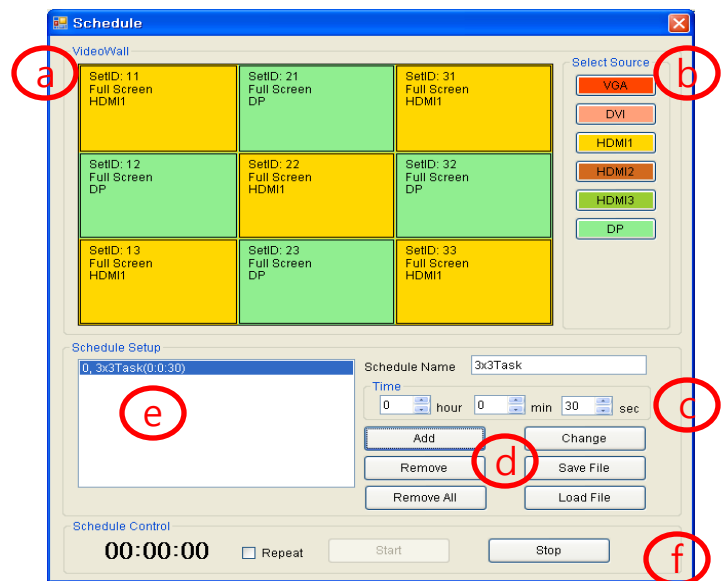

Virtual Skylight Display Control Program

Menu Bar 1

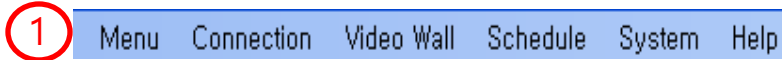

System -Setup

Board Type: make a choice MINERVA selection.

MINERVA Option: Linker Board

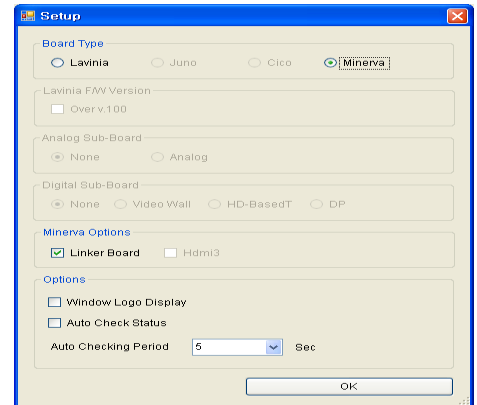

Menu Bar 2



Control Start

After adjusting settings, select "Control Start". To stop communication, select "Control Stop"



Target Monitor

Select the SET ID of the control monitor

All Monitor

Conduct control on all monitors in video wall at once

Connection

The same function as Menu Bar 1.

Video wall

The same function as Menu Bar 1

Set up

The same function as Menu Bar 1

Schedule

The same as the Schedule item in Menu Bar 1.

Virtual Skylight Display Control Program



Menu Bar 3

3

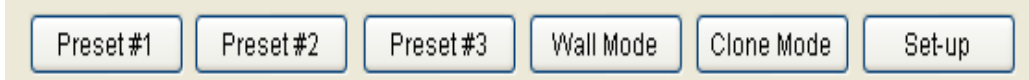

Preset

Used when loading previously-saved settings.

Wall Mode

Expands input source signal across entire video wall array.

Clone Mode

Shows input source signal on each individual display (signal duplicated on each screen).

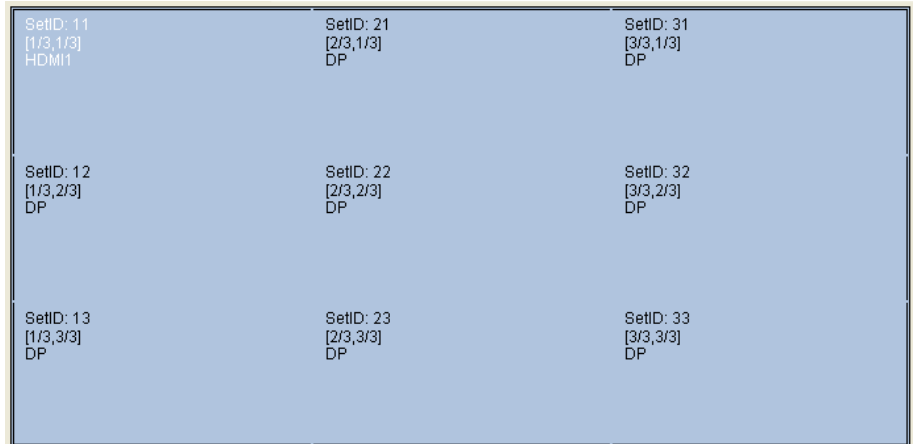
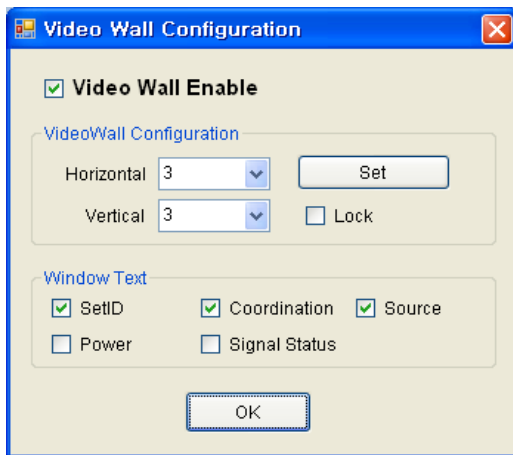

[Wall Mode-Video wall Mode]

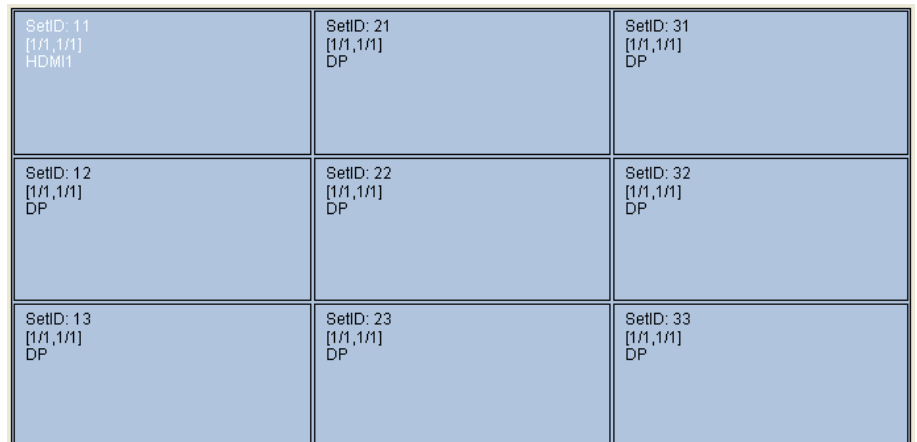

[Clone Mode-Single Mode]

Menu Bar 4-Status

Information - a

Shows status readout of selected monitor

Right-click in the video wall window and then select "read status".

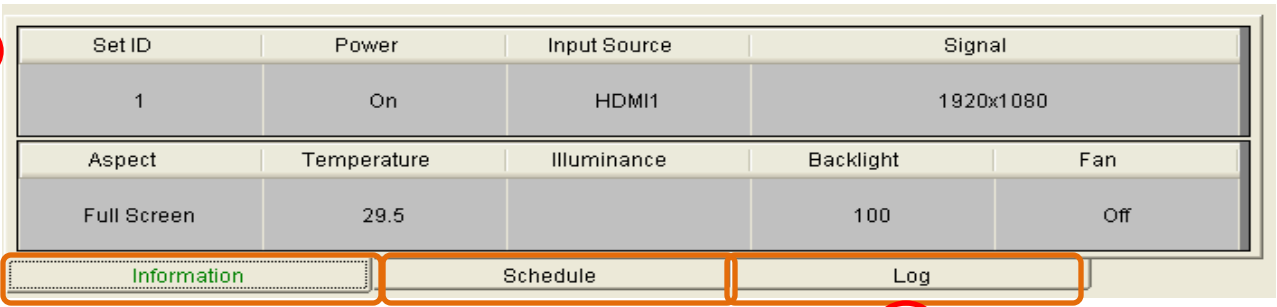

4

Set ID	Power	Input Source	Signal
1	On	HDMI1	1920x1080

Aspect	Temperature	Illuminance	Backlight	Fan
Full Screen	29.5		100	Off

Information Schedule Log

a b c

Schedule - b

This shows any schedules set for the monitor.

Please refer to the schedule function for more info on scheduling.

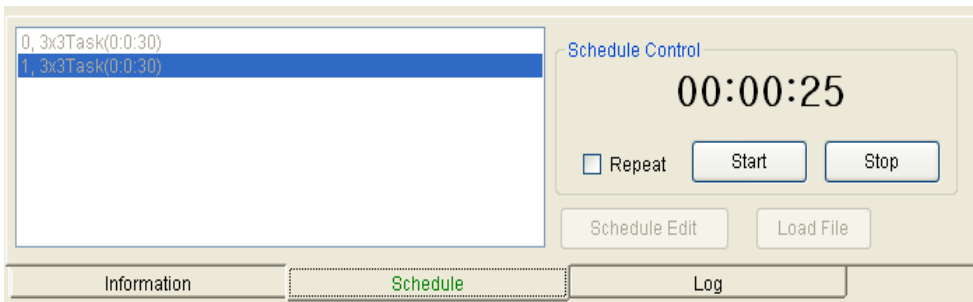

Schedule Control

00:00:25

Repeat Start Stop

Schedule Edit Load File

Information Schedule Log

Log - c

Shows past control functions visited on monitor.

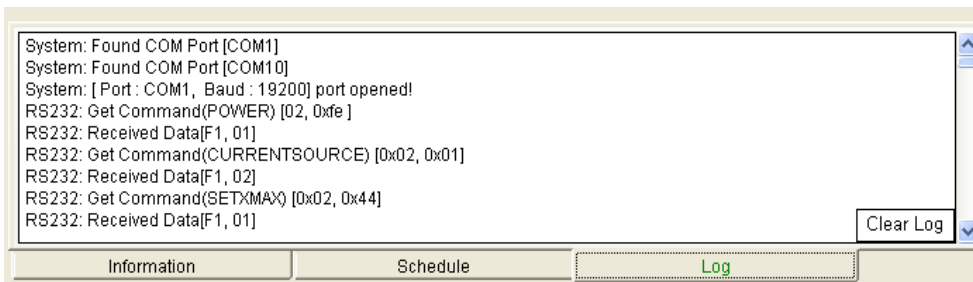

```
System: Found COM Port [COM1]
System: Found COM Port [COM10]
System: [ Port : COM1 , Baud : 19200 ] port opened!
RS232: Get Command(POWER) [02, 0xfe ]
RS232: Received Data[F1, 01]
RS232: Get Command(CURRENTSOURCE) [0x02, 0x01]
RS232: Received Data[F1, 02]
RS232: Get Command(SETXMAX) [0x02, 0x44]
RS232: Received Data[F1, 01]
```

Clear Log

Information Schedule Log

Menu Bar 4-Status

Information - a

The user can check the current state of the monitor

Press the right button of the mouse in the video wall window, and then select read status.

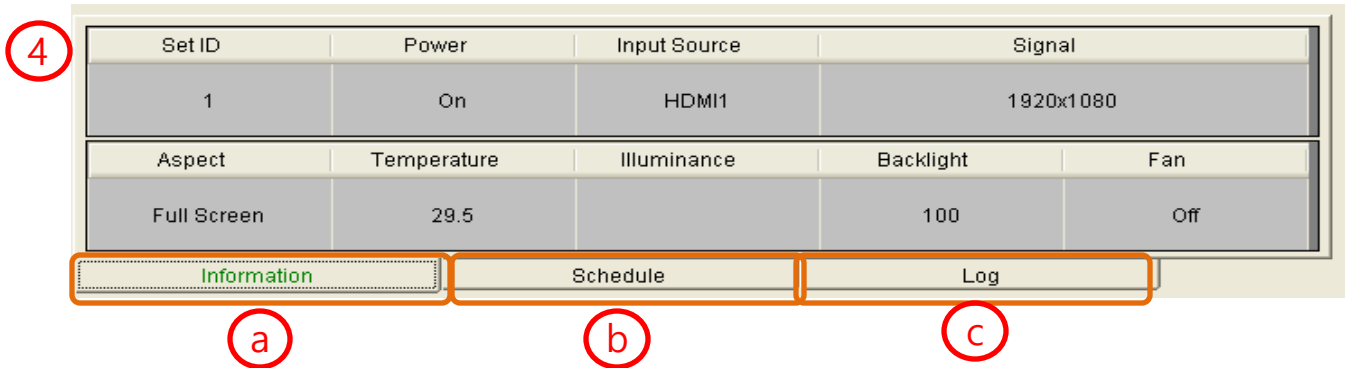

Schedule - b

The user can check the schedule state of the monitor.

Please refer to the schedule function.

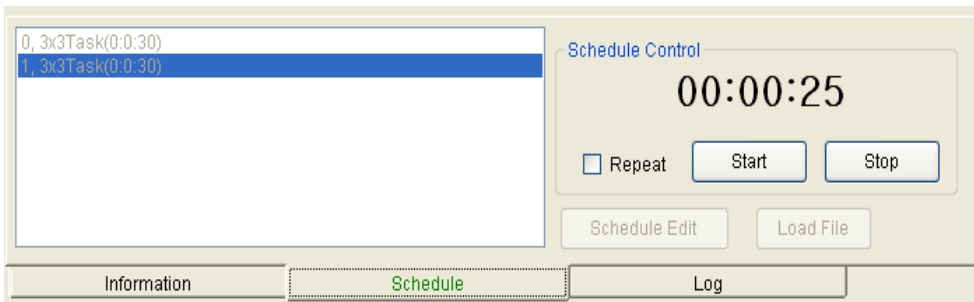

Log - c

The user can confirm the record of the execution of the program

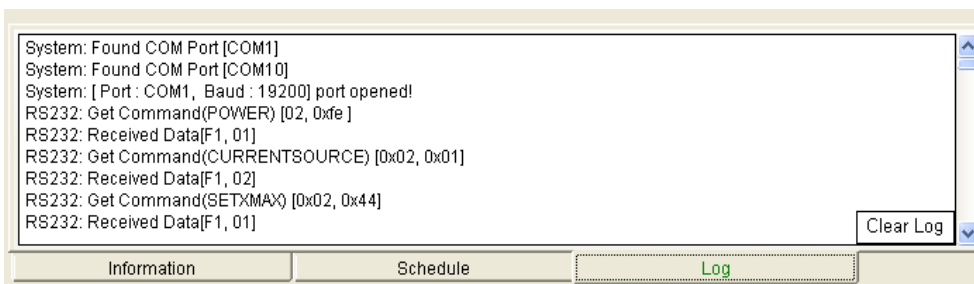

Virtual Skylight Display Control Program

Menu Bar 5 – Control function

Control Function

See below for a look at each control tab:

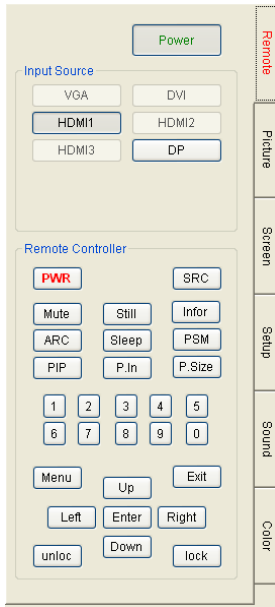

[Remote control]

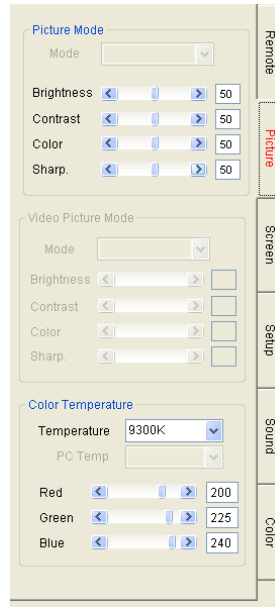

[Picture]

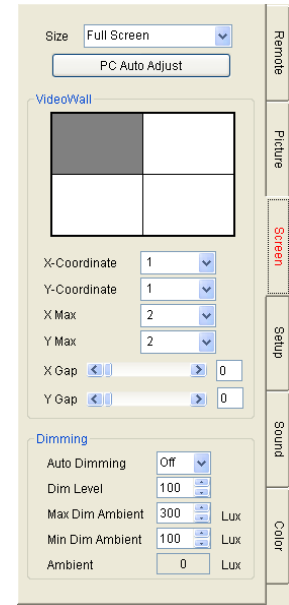

[Screen]

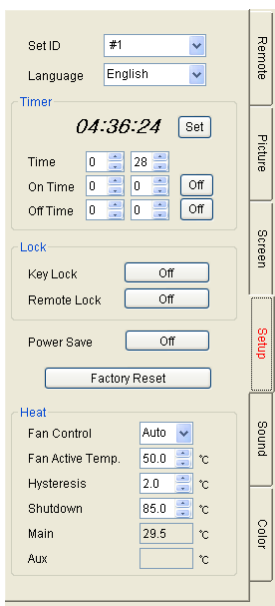

[Setup]

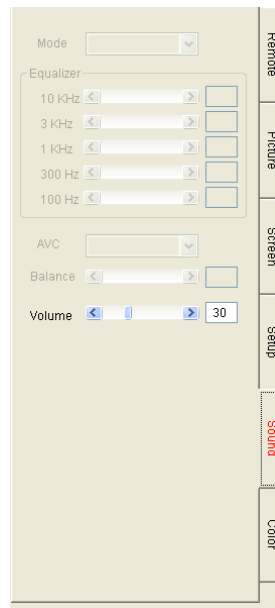

[Sound]

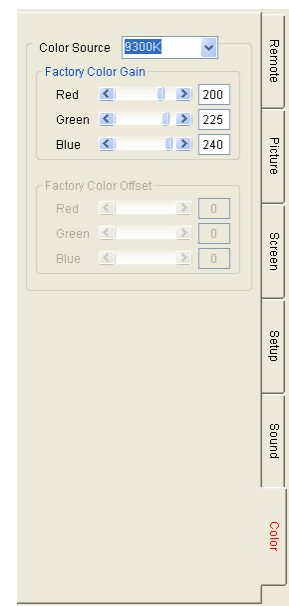

[Color]

Virtual Skylight Display Control Program

Example

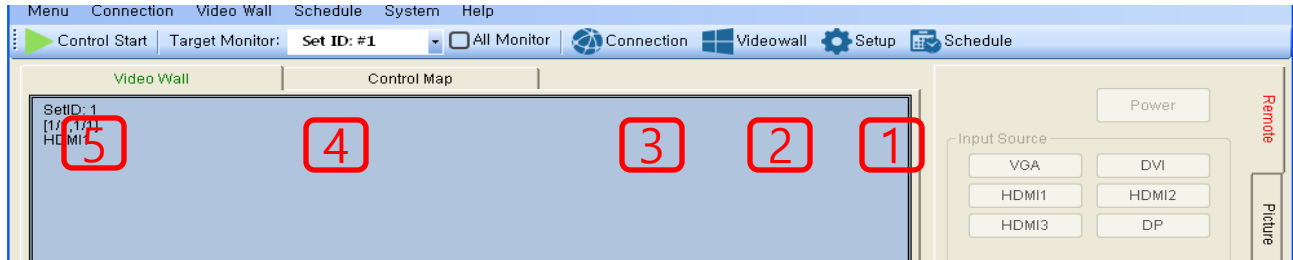

Control Procedure

1) Setup

Select the model

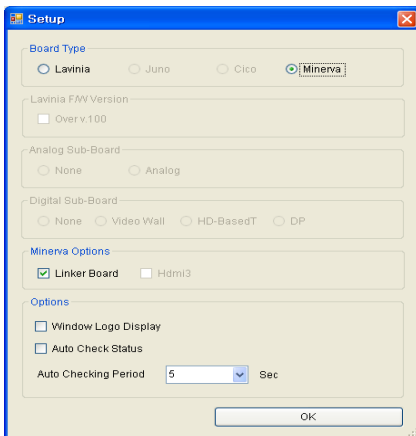

2) Video Wall Configuration

Select desired configuration

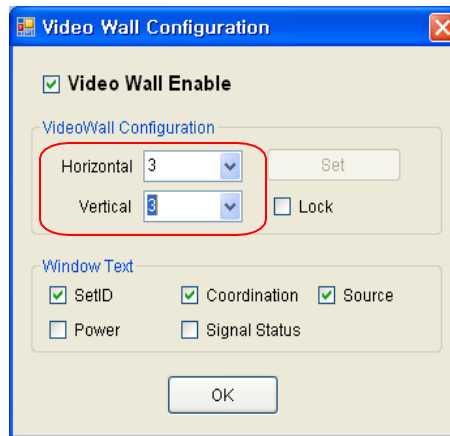

3) Connection

Select connection method (Serial or TCP/IP)

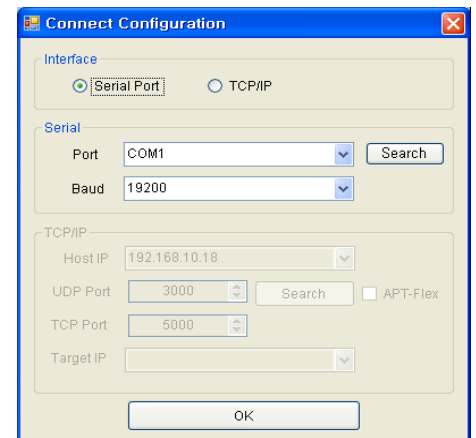

4) SET ID

Assign Set ID #'s to monitors

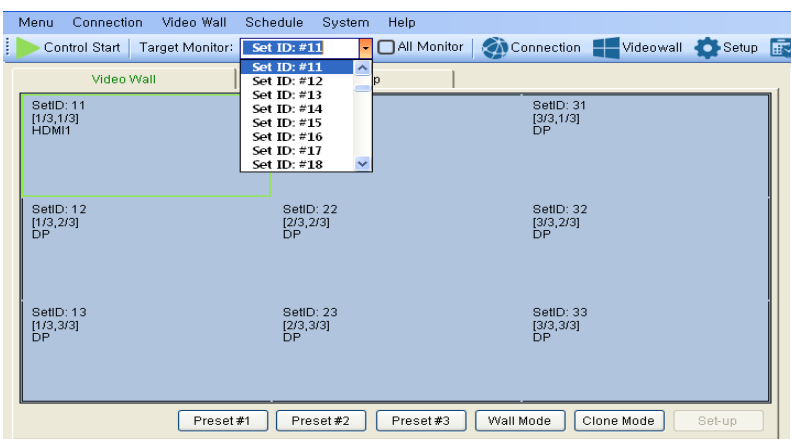

5) Control Start



Support Signals

Items		Specifications
Supported Signals	UHD INTERFACE HDMI, DP	H Frequency Range : 20~82 kHz
		V Frequency Range : 55 ~ 90 Hz (VESA standard)
		Maximum resolution : 3840x2160@60Hz
		Maximum pixel rate : 594 MHz
	HD-SDI (Optional)	HD-SDI : 2.970Gbps S D-SDI : 270Mbps

Supported 4K Format

	HDMI Input				DP Input			
	8bit	10bit	12bit	16bit	8bit	10bit	12bit	16bit
4K 2K@30Hz	RGB 4:4:4	RGB 4:4:4	RGB 4:4:4 4:2:2	RGB 4:4:4	RGB 4:4:4	RGB 4:4:4	RGB 4:4:4 4:2:2	RGB 4:4:4
4K 2K @60Hz	4:2:0	4:2:0	4:2:2 4:2:0	4:2:0	RGB 4:4:4 4:2:0	4:2:0	4:2:2 4:2:0	4:2:0

Serial Interface Communication Protocol

[Virtual Skylight_Rev2.0]

◆ SICP (Serial Interface Communication Protocol)

This document defines all the command and messages exchanged between the Master (a PC or the other controller) and the Slave (the displays).

It also describes the ways to send or read the commands or the messages.

1. Protocol definition

SICP stands for "Serial Interface Communication Protocol".

The protocol is specifically designed to allow data communication in half duplex multi-point environments, but it can also be used for half duplex point-to-point RS-232C communication.

2. Communication characteristics

A half duplex communication is implemented starting from the concept of a master-slave structure, where the display is supposed to be the slave.

The first action is always taken by the master, which can be either a PC or any controlling device (acting as server) interfaced to the monitor. After sending a command or a request in the appropriate format the master receives from the slave an acknowledgement, which tells the transmitter whether the command is not valid (or not executable, anyway) or it is accepted. In case of a request, the requested information is sent back and it becomes the acknowledgement by itself.

3. How to connect control devices (simple null modem cable)

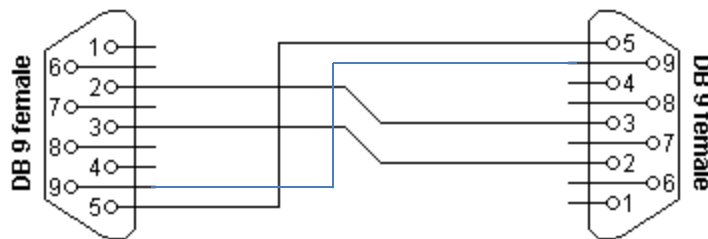

Connector 1	Connector 2	Function
2	3	Rx ← Tx
3	2	Tx → Rx
5	5	Signal ground

*9-9: IR LOOP signal

4. Hardware Protocol

Baud rate : 19200 bps

Data bits : 8 bit

Parity bits : None

Stop bits : 1 bit

Handshake : None

5. Protocols Formats by DSUB 9Pin RS232 Serial Port

This is the format that the computer will send to the display to execute commands.
The format for this command transmission is as follows

◆ Setting Command to Display (5bytes)

STX	R/W	ID	CON	COM	Value
0xF5	0x88	Set ID (0x00~0x63)	0xFE	0xFF	0xFF

STX : Start of Text (0xFF)

F = Command Start Sending, X = Number of Byte to Send

Example (0xF4) : Start Sending 4 Bytes of Packet Data

(Using for Parameter Reading or Virtual Remote Control)

(0xF5) : Start Sending 5 Bytes of Packet Data

(Using for Parameter Setting)

R/W : Read and Write Protocol

0x88 = Write (Command for Setting)

ID : SET ID Number (Set ID 0~99)

0x00 = Wildcard (All Sets)

0x01 (Set ID# 1), 0x02 (Set ID# 2), 0x0C (Set ID# 12), 0x10 (Set ID# 16),

CON : Control Command

0xFE = Set Command Control, 0xFD = Set Virtual Remote Control

COM : COMMAND (ex, 0xFE : Power , 0x01 : Input source...)

Value : COMMAND VALUE (ex 0x00 : POWER OFF, 0x01 : POWER ON)

Acknowledgement

0xF1	Check Sum
------	-----------

◆ Read Command from Display(4bytes)

STX	R/W	ID	CON	COM
0xF4	0x89	Set ID (0x00~0x63)	0xFE	0xFF

STX: 0xF4 (start sending 4 bytes of packet data)

R/W: Read and Write Protocol

0x89 = Read (Command for getting)

ID : SET ID Number (Set ID 0~99)

0x01 (Set ID# 1), 0x02 (Set ID# 2), 0x0C (Set ID# 12), 0x10 (Set ID# 16)

CON : Control Command

0xFE = Set Command Control, 0xFD = Set Virtual Remote Control

COM : COMMAND (ex, 0xFE : Power , 0x01 : Input source...)

Acknowledgement

0xF1	Value
------	-------

5. Protocols Formats by DSUB 9Pin RS232 Serial Port

◆ Virtual Remote Control(4bytes)

STX	R/W	ID	CON	Value
0xF4	0x88	Set ID (0x00~0x63)	0xFD	KEY CODE

STX : Start of Text (0xFX)

F = Command Start Sending, X = Number of Byte to Send

Example (0xF4) : Start Sending 4 Bytes of Packet Data

(Using for Parameter Reading or Virtual Remote Control)

(0xF5) : Start Sending 5 Bytes of Packet Data

(Using for Parameter Setting)

R/W : Read and Write Protocol

0x88 = Write (Command for Setting)

ID : SET ID Number (Set ID 0~99)

0x00 = Wildcard (All Sets)

0x01 (Set ID# 1), 0x02 (Set ID# 2), 0x0C (Set ID# 12), 0x10 (Set ID# 16),

CON : Control Command

0xFE = Set Command Control, 0xFD = Set Virtual Remote Control

Value : Key code

(ex. KEY POWER = 0x11. KEY INPUT = 0x13 etc)

Acknowledgement

0xF0

Button	Key Code
KEY_POWER	0x11
KEY_INPUT	0x13
KEY_MENU	0x43
KEY_EXIT	0x50
KEY_UP	0x47
KEY_DOWN	0x4B
KEY_LEFT(VOL -)	0x57
KEY_RIGHT(VOL +)	0x53
KEY_ENTER	0x04
KEY_MUTE	0x03
KEY_STILL	0x0A
KEY_INFO	0x06
KEY_SLEEP	0x0B
SET ID	0x51
SET ID EXIT	0x55

6. Protocols Formats by Ethernet Port

To set up the parameters to Displays, transfer the following instruction.

Transport Layer : TCP

Port : 5000

Command : *Ethernet Command + **Serial Command

*** Ethernet CMD : ASCII : DCOM**

HEX : 0x44 0x43 0x4F 0x4D

◆ Setting Commands to Displays

Ethernet CMD				Serial CMD					
DA 1	DA2	DA3	DA4	STX	R/W	ID	CON	CMD	Value
D	C	O	M	0xF5	0x88	Set ID (0x00~0x63)	0xFE	0XX	0XX
ASCII				Hex					

* Ethernet Command

DA1~DA4: Ethernet Command

ASCII Code: DCOM

Hex Code: 0x44 0x43 0x4F 0x4D

* Serial Command

STX : Start of Text (0xFX)

F = Command Start Sending, X = Number of Byte to Send

Example (0xF4) : Start Sending 4 Bytes of Packet Data

(Using for Parameter Reading or Virtual Remote Control)

(0xF5) : Start Sending 5 Bytes of Packet Data

(Using for Parameter Setting)

R/W : Read and Write Protocol

0x88 = Write (Command for Setting)

ID : SET ID Number (Set ID 0~99)

0x00 = Wildcard (All Sets)

0x01 (Set ID# 1), 0x02 (Set ID# 2), 0x0C (Set ID# 12), 0x10 (Set ID# 16),

CON : Control Command

0xFE = Set Command Control, 0xFD = Set Virtual Remote Control

COM : COMMAND (ex, 0xFE : Power , 0x01 : Input source...)

Value : COMMAND VALUE (ex 0x00 : POWER OFF, 0x01 : POWER ON)

❖ Acknowledgement;

Ethernet CMD(4bytes)				Serial CMD(1byte)
D	C	O	M	0xF0

• Example

Switch to DP source – Set ID # 01

Ethernet CMD				Serial CMD					
DA 1	DA2	DA3	DA4	STX	R/W	ID	CON	CMD	Value
0x44	0x43	0x4F	0x4D	0xF5	0x88	0x01	0xFE	0x01	0x01

Acknowledgement

DA 1	DA2	DA3	DA4	Value
0x44	0x43	0x4F	0x4D	0xF0

6. Protocols Formats *by Ethernet Port*



◆ Read Command from Display

Ethernet CMD				Serial CMD				
DA 1	DA2	DA3	DA4	STX	R/W	ID	CON	CMD
D	C	O	M	0xF4	0x89	Set ID (0x00~0x63)	0xFE	0xXX
ASCII				Hex				

* Ethernet Command

DA1~DA4: Ethernet Command

ASCII Code: DCOM

Hex Code: 0x44 0x43 0x4F 0x4D

* Serial Command

STX: 0xF4 (start sending 4 bytes of packet data)

R/W: Read and Write Protocol

0x89 = Read (Command for getting)

ID : SET ID Number (Set ID 0~99)

0x01 (Set ID# 1), 0x02 (Set ID# 2), 0x0C (Set ID# 12), 0x10 (Set ID# 16)

CON : Control Command

0xFE = Set Command Control, 0xFD = Set Virtual Remote Control

COM : COMMAND (ex, 0xFE : Power , 0x01 : Input source...)

❖ Acknowledgement;

Ethernet CMD				Serial CMD	
D	C	O	M	0xF1	Value

• Example

Check Current Source – Set ID # 01 (DP)

DA 1	DA2	DA3	DA4	STX	R/W	ID	CON	CMD
D	C	O	M	0xF4	0x89	0x01	0xFE	0x01

❖ Acknowledgement

DA 1	DA2	DA3	DA4	CMD	Value
0x44	0x43	0x4F	0x4D	0xF1	0x01

6. Protocols by Ethernet Port

◆ VIRTUAL remote

Ethernet CMD(4bytes)				Serial CMD(4bytes)				
DA 1	DA2	DA3	DA4	STX	R/W	ID	CON	CMD
D	C	O	M	0xF4	0x88	Set ID (0x00~0x63)	0xFD	KEY CODE
ASCII				Hex				

* Ethernet Command

ASCII Code: DCOM

Hex Code: 0x44 0x43 0x4F 0x4D

* Serial Command

STX : Start of Text (0xFX)

F = Command Start Sending, X = Number of Byte to Send

Example (0xF4) : Start Sending 4 Bytes of Packet Data

(Using for Parameter Reading or Virtual Remote Control)

(0xF5) : Start Sending 5 Bytes of Packet Data

(Using for Parameter Setting)

R/W : Read and Write Protocol

0x88 = Write (Command for Setting)

ID : SET ID Number (Set ID 0~99)

0x00 = Wildcard (All Sets)

0x01 (Set ID# 1), 0x02 (Set ID# 2), 0x0C (Set ID# 12), 0x10 (Set ID# 16),

CON : Control Command

0xFE = Set Command Control, 0xFD = Set Virtual Remote Control

Value : Key code

(ex. KEY POWER = 0x11. KEY INPUT = 0x13 etc)

❖ Acknowledgement;

Ethernet CMD(4bytes)				Serial CMD(1byte)
D	C	O	M	0xF0

• Example

Check Current Source – Set ID # 01

DA 1	DA2	DA3	DA4	STX	R/W	ID	CON	CMD
D	C	O	M	0xF4	0x88	0x01	0xFD	11

❖ Acknowledgement

Ethernet CMD(4bytes)				Serial CMD(1byte)
D	C	O	M	0xF0

Button	Key Code
KEY_POWER	0x11
KEY_INPUT	0x13
KEY_MENU	0x43
KEY_EXIT	0x50
KEY_UP	0x47
KEY_DOWN	0x4B
KEY_LEFT(VOL -)	0x57
KEY_RIGHT(VOL +)	0x53
KEY_ENTER	0x04
KEY_MUTE	0x03
KEY_STILL	0x0A
KEY_INFO	0x06
KEY_SLEEP	0x0B
SET ID	0x51
SET ID EXIT	0x55

7. Command List

7.1 Main Function Settings

◆ Set Power On/Off (0xFE)

STX	R/W	ID	CON	CMD	Value
0xF5	0x88	0x00 – 0x63	0xFE	0xFE	0xFF

STX : Start of Text (0xFF)

0xF5 : Start Sending 5 Bytes of Packet Data

R/W : Read and Write Protocol

0x88 = Write (Command for writing Protocol)

ID : SET ID Number (Set ID 0~99)

0x00 = Wildcard (All Sets)

0x01 (Set ID# 1), 0x02 (Set ID# 2), 0x0C (Set ID# 12), 0x10 (Set ID# 16),

CON : 0xFE (Set Control command)

COM : 0xFE for Power ON/OFF Command

Value : 0x00 (OFF), 0x01 (ON)

◆ Read(Get) Power Status(0xFE)

STX	R/W	ID	CON	CMD
0xF4	0x89	0x00 – 0x63	0xFE	0xFE

STX: 0xF4 (start sending 4 bytes of packet data)

R/W: Read and Write Protocol

0x89 = Read (Command for getting protocol)

ID : SET ID Number (Set ID 0~99)

0x01 (Set ID# 1), 0x02 (Set ID# 2), 0x0C (Set ID# 12), 0x10 (Set ID# 16)

CON : Control Command

0xFE = Set Command Control

COM : 0xFE (Power on/off command)

◆ Remote Control Lock On/Off

STX	R/W	ID	CON	CMD	Value
0xF5	0x88	0x00 – 0x63	0xFE	0x36	0xFF

- CMD: 0x36 for command of Remote Control Lock
- Value: 0x00 for OFF
0x01 for ON

◆ Source Change

STX	R/W	ID	CON	CMD	Value
0xF5	0x88	0x00 – 0x63	0xFE	0x01	0xFF

- CMD: 0x01 for command of Video Input Source
- Value: 0x01 for Display Port
0x02 for HDMI

◆ Temperature Reading

STX	R/W	ID	CON	CMD
0xF4	0x89	0x00 – 0x63	0xFC	0x3C

- CMD: 0x3C for Current Temperature Reading
- Value = Actual Temperature (by Celsius) x 2 + 60
Ex) If reading value is 122 (0x7A),
Actual Temperature = (122 – 60) / 2 = 31°C

◆ Temperature Shutdown Setting

STX	R/W	ID	CON	CMD	Value
0xF5	0x88	0x00 – 0x63	0xFE	0x48	0xFF

- CMD: 0x48 for Shutdown Temperature setting
- Value = desired shutdown temperature (by Celsius) x 2 + 60
Ex) If desired shutdown temperature is 60°C,
Setting Value = 60 x 2 + 60 = 180 (0xB4)

◆ MFC Setting (Motion Flow Compensation)

STX	R/W	ID	CON	CMD	Value
0xF5	0x88	0x00 – 0x63	0xFE	0x6A	0xFF

- CMD: 0x6A for MFC Setting (Motion Flow Compensation)
- Value: 0x00 (OFF), 0x01 (LOW), 0x02 (MIDDLE), 0x03 (HIGH)

7.2 Video wall Settings (Multi Vision)

◆ Write Set ID Number

* Attention : Write Set ID Function must be only one connect Monitor (1 pc : 1 monitor)

STX	R/W	ID	CON	CMD	Value
0xF5	0x88	0x00 – 0x63	0xFE	0x2A	0xFF

ID : SET ID Number (Set ID 0~99)

0x01 (Set ID# 1), 0x02 (Set ID# 2), 0x0C (Set ID# 12), 0x10 (Set ID# 16) R/W: 0xFE (Set Parameter Value)

CMD: 0x2A for SETID

Value: 0x00 – 0x63 (0 – 99)

◆ Horizontal Set Max Count

STX	R/W	ID	CON	CMD	Value
0xF5	0x88	0x00 – 0x63	0xFE	0x44	0xFF

CMD: 0x44 for X max

Value: 0x01 – 0x0B (1 – 11)

◆ Vertical Set Max Count

STX	R/W	ID	CON	CMD	Value
0xF5	0x88	0x00 – 0x63	0xFE	0x45	0xFF

Param: 0x45 for Y max

Value: 0x01 – 0x0B (1 – 11)

◆ Horizontal Set Position

STX	R/W	ID	CON	CMD	Value
0xF5	0x88	0x00 – 0x63	0xFE	0x42	0xFF

CMD: 0x42 for X Position

Value: 0x01 – 0x0B (1 – 11)

◆ Vertical Set Position

STX	R/W	ID	CON	CMD	Value
0xF5	0x88	0x00 – 0x63	0xFE	0x43	0xFF

CMD: 0x43 for Y Position

Value: 0x01 – 0x0B (1 – 11)

◆ Horizontal Gap Adjust

STX	R/W	ID	CON	CMD	Value
0xF5	0x88	0x00 – 0x63	0xFE	0x46	0xFF

- CMD: 0x46 for X GAP
- Value: 0x03 for UNB (3.5mm B2B)
0x02 for ENB (1.8mm B2B)

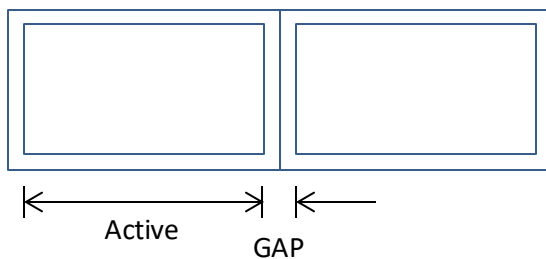

◆ Vertical Gap Adjust

STX	R/W	ID	CON	CMD	Value
0xF5	0x88	0x00 – 0x63	0xFE	0x47	0xFF

- CMD: 0x47 for Y GAP
- Value: 0x05 for UNB (3.5mm B2B)
0x03 for ENB (1.8mm B2B)

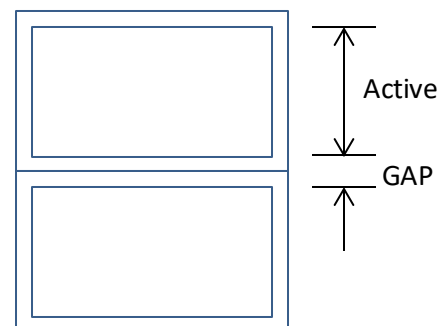

Example) 55" UNB Videowall Display (2x2)

SetID#1	SetID#2
SetID#3	SetID#4

1. **Set ID must be set before Videowall Display installation**
2. Set Videowall mode for 2x2 configuration
3. Command set for Set ID 1
 - 0xF5 0x88 0x01 0xFE 0x44 0x02 (X Max=2)
 - 0xF5 0x88 0x01 0xFE 0x45 0x02 (Y Max=2)
 - 0xF5 0x88 0x01 0xFE 0x42 0x01 (X POS=1)
 - 0xF5 0x88 0x01 0xFE 0x43 0x01 (Y POS=1)
 - 0xF5 0x88 0x01 0xFE 0x46 0x03 (X GAP=3)
 - 0xF5 0x88 0x01 0xFE 0x47 0x05 (Y GAP=5)
4. Parameter set for Set ID 2
 - 0xF5 0x88 0x02 0xFE 0x44 0x02 (X Max=2)
 - 0xF5 0x88 0x02 0xFE 0x45 0x02 (Y Max=2)
 - 0xF5 0x88 0x02 0xFE 0x42 0x02 (X POS=2)
 - 0xF5 0x88 0x02 0xFE 0x43 0x01 (Y POS=1)
 - 0xF5 0x88 0x02 0xFE 0x46 0x03 (X GAP=3)
 - 0xF5 0x88 0x02 0xFE 0x47 0x05 (Y GAP=5)
5. Parameter set for Set ID 3
 - 0xF5 0x88 0x03 0xFE 0x44 0x02 (X Max=2)
 - 0xF5 0x88 0x03 0xFE 0x45 0x02 (Y Max=2)
 - 0xF5 0x88 0x03 0xFE 0x42 0x01 (X POS=1)
 - 0xF5 0x88 0x03 0xFE 0x43 0x02 (Y POS=2)
 - 0xF5 0x88 0x03 0xFE 0x46 0x03 (X GAP=3)
 - 0xF5 0x88 0x03 0xFE 0x47 0x05 (Y GAP=5)
6. Parameter set for Set ID 4
 - 0xF5 0x88 0x04 0xFE 0x44 0x02 (X Max=2)
 - 0xF5 0x88 0x04 0xFE 0x45 0x02 (Y Max=2)
 - 0xF5 0x88 0x04 0xFE 0x42 0x02 (X POS=2)
 - 0xF5 0x88 0x04 0xFE 0x43 0x02 (Y POS=2)
 - 0xF5 0x88 0x04 0xFE 0x46 0x03 (X GAP=3)
 - 0xF5 0x88 0x04 0xFE 0x47 0x05 (Y GAP=5)

7.3 Picture Control Settings

◆ Contrast

STX	R/W	ID	CON	CMD	Value
0xF5	0x88	0x00 – 0x63	0xFE	0x04	0xFF

- CMD: 0x04 for Contrast
- Value: 0x00 – 0x64 (0 – 100)

◆ Brightness

STX	R/W	ID	CON	CMD	Value
0xF5	0x88	0x00 – 0x63	0xFE	0x05	0xFF

- CMD: 0x05 for Brightness
- Value: 0x00 – 0x64 (0 – 100)

◆ Sharpness

STX	R/W	ID	CON	CMD	Value
0xF5	0x88	0x00 – 0x63	0xFE	0x07	0xFF

- CMD : 0x07 for Sharpness
- Value: 0x00 – 0x64 (0 – 100)

◆ Aspect Ratio

STX	R/W	ID	CON	CMD	Value
0xF5	0x88	0x00 – 0x63	0xFE	0x0F	0xFF

- CMD : 0x0F for Aspect Ratio
- Value: 0x01 (Full Screen), 0x02 (4:3), 0x03 (5:4), 0x04 (16:9), 0x05 (1:1, no aspect ratio change)

◆ Auto Dimming

STX	R/W	ID	CON	CMD	Value
0xF5	0x88	0x00 – 0x63	0xFE	0x3A	0xFF

- CMD : 0x3A for Auto Dimming Mode
- Value: 0x00 (OFF), 0x01 (ON)

◆ Dimming Control

STX	R/W	ID	CON	CMD	Value
0xF5	0x88	0x00 – 0x63	0xFE	0x3B	0xFF

- CMD: 0x3B for DIM LEVEL control
- Value: 0x00 – 0x64 (0 – 100)
 0 -> Min Brightness
 100 -> Max Brightness

◆ Max Ambient Illuminance

STX	R/W	ID	CON	CMD	Value
0xF5	0x88	0x00 – 0x63	0xFE	0x38	0xFF

- CMD: 0x38 for MAX AMBIENT ILLUMINANCE Setting
- Value: 0x02– 0x00 (2 – 255 = 200 - 25000)
 Setting Value = Ambient Level (by LUX) / 100
 Ex) Desired Ambient is 10000Lux, setting value is 100 (0x64) (= 10000 / 100)

◆ Min Ambient Illuminance

STX	R/W	ID	CON	CMD	Value
0xF5	0x88	0x00 – 0x63	0xFE	0x39	0xFF

- CMD: 0x39 for MIN AMBIENT ILLUMINANCE Setting
- Value: 0x01– 0x00 (1 – 255 = 10 - 2550)
 Setting Value = Ambient Level (by LUX) / 10
 Ex) Desired Ambient is 200Lux, setting value is 20 (0x14) (= 200 / 10)

7.4 Color Control Settings

◆ Color Temperature

STX	R/W	ID	CON	CMD	Value
0xF5	0x88	0x00 – 0x63	0xFE	0x03	0xFF

- CMD: 0x03 for Color Temperature Control
- Value: 0x00 (3200K), 0x01 (5600K), 0x02 (6500K),
0x03 (7800K), 0x04 (9300K),
0x05 (USER) : user setting will use RGB gain setting values.

7.5 Timer Setting

◆ Current Hour

STX	R/W	ID	CON	CMD	Value
0xF5	0x88	0x00 – 0x63	0xFE	0x32	0xFF

- CMD: 0x32 for Current Time Hour
- Value: 0x00 – 0x17 (0 – 23)

◆ Current Minute

STX	R/W	ID	CON	CMD	Value
0xF5	0x88	0x00 – 0x63	0xFE	0x33	0xFF

- CMD: 0x33 for Current Time Minute
- Value: 0x00 – 0x3B (0 – 59)

◆ On Time Hour

STX	R/W	ID	CON	CMD	Value
0xF5	0x88	0x00 – 0x63	0xFE	0x23	0xFF

- CMD: 0x23 for On Time Hour
- Value: 0x00 – 0x23 (0 – 17)

◆ On Time Minute

STX	R/W	ID	CON	CMD	Value
0xF5	0x88	0x00 – 0x63	0xFE	0x24	0xFF

- CMD: 0x24 for On Time Minute
- Value: 0x00 – 0x3B (0 – 59)

◆ On Time ON/OFF

STX	R/W	ID	CON	CMD	Value
0xF5	0x88	0x00 – 0x63	0xFE	0x25	0xFF

- CMD: 0x25 for On Time ON/OFF control
- Value: 0x00 (OFF), 0x01 (ON)

◆ Off Time Hour

STX	R/W	ID	CON	CMD	Value
0xF5	0x88	0x00 – 0x63	0xFE	0x27	0xFF

- CMD: 0x27 for Off Time Hour
- Value: 0x00 – 0x23 (0 – 17)

◆ Off Time Minute

STX	R/W	ID	CON	CMD	Value
0xF5	0x88	0x00 – 0x63	0xFE	0x28	0xFF

- CMD: 0x28 for Off Time Minute
- Value: 0x00 – 0x3B (0 – 59)

◆ Off Time ON/OFF

STX	R/W	ID	CON	CMD	Value
0xF5	0x88	0x00 – 0x63	0xFE	0x29	0xFF

- CMD: 0x29 for Off Time ON/OFF control
- Value: 0x00 (OFF), 0x01 (ON)

Supported Timing: UHD (HDMI, DP)

Resolution	H-Frequency (kHz)	V-Frequency (Hz)	Pixel Frequency (MHz)	Comment
640x480	31.469	59.94	25.175	
640x480	37.500	75.0	31.5	
800x600	37.879	60.317	40.0	
800x600	46.875	75.0	49.5	
1024x768	48.780	60.001	64.11	
1024x768	56.476	70.069	75.0	
1024x768	60.030	75.029	78.75	
1280x720	47.760	60.0	74.481	
1280x720	52.500	70.0	89.040	
1280x768	60.150	75.0	102.977	
1280x1024	63.600	60.0	108.883	
1360x768	47.700	60.0	84.700	
1600x1200	75.000	60.0	162.000	
720x576	15.735	50.0	13.595	
720x480	31.469	59.94	25.175	
1280x720	44.964	59.94	74.176	
1920x1080	33.750	60.0	74.25	
1920x1080	31.250	50.0	72.000	
1920x1080	56.3	50	148.5	
1920x1080	67.5	60	148.5	
3840x2160	67.5	30	297	
3840x2160	135	60	594	

Support Signals

Items		Specifications
Supported Signals	UHD INTERFACE HDMI, DP	H Frequency Range : 20~82 kHz
		V Frequency Range : 55 ~ 90 Hz (VESA standard)
		Maximum resolution : 3840x2160@60Hz
		Maximum pixel rate : 594 MHz
	HD-SDI (Optional)	HD-SDI : 2.970Gbps SD-SDI : 270Mbps

Supported 4K Format

	HDMI Input				DP Input			
	8bit	10bit	12bit	16bit	8bit	10bit	12bit	16bit
4K 2K@30Hz	RGB 4:4:4	RGB 4:4:4	RGB 4:4:4 4:2:2	RGB 4:4:4	RGB 4:4:4	RGB 4:4:4	RGB 4:4:4 4:2:2	RGB 4:4:4
4K 2K @60Hz	4:2:0	4:2:0	4:2:2 4:2:0	4:2:0	RGB 4:4:4 4:2:0	4:2:0	4:2:2 4:2:0	4:2:0

Specifications



Screen Size (Diag.)	46"
Panel Technology	Commercial-grade Direct-LED backlight
Resolution	1920 x 1080
Pixel Pitch (mm)	0.53025 (H) x 0.53025 (V)
Surface Treatment	Anti-Glare coating (3H), Haze 11% (Typ.)
Brightness (Typ.)	700nit
Contrast Ratio (Typ.)	4,000:1
Displayable Colors	10bit(D), 1073,7 Million colors
Viewing Angle	178° (min) / 178° (min)
Response Time (Typ. GTG)	6.5ms
Aspect Ratio	16:9
Refresh rate	60Hz

Dimensions, Power & Other

Dimension (W x H x D), Weight	47.74" x 23.74" x 3" / 55lbs
VESA Pattern (mm)	400 x 400
Electrical Ratings	AC 100 - 240V (50/60Hz)
Power Consumption (Max.)	120W / 1.5A
BTU rating (Typ.)	461
Mullion Compensation	SICP software or Remote control
Operating Temperature	32°F - 104°F
Operating Humidity Range	10~80%
Possible Display Type	Landscape and Portrait-Compatible
Industrial Reliability	50,000+ Hours
Warranty	Three Years

Connectivity

DisplayPort (up to 3840 x 2160)	1 x Input
HDMI (up to 3840 x 2160)	1 x Input, 1 x output
RS-232	1 x Input, 1 x output
Ethernet RJ45 (Optional_ for control & monitoring)	1 x Input
USB (for service only)	1 x Input

Certification

Safety	UL (USA) : UL 60950-1 and 2043 CSA (Canada) : CAN/CSA C22.2 No. 60950-1-07 CE(Europe) : EN 60950-1:2006 + A11:2009 + A1:2010 + A12:2011 + A2:2013 RCM(Australia) :AS/NZS 60950.1:2015 IEC 60950-1:2005 (Second Edition) + Am 1:2009 + Am 2:2013
EMC	FCC (USA) FCC class B CE (Europe): EN55032 / EN55024 Australia:EN55032 / EN55024 EN 60950 1:2006 / A11:2009 / A1:2010 / A12:2011/A2:2013 ICES-003